

LW SERIES

5W WIDE INPUT RANGE

DANUBE

FEATURES

- 5W DIL PACKAGE
- INDUSTRY STANDARD PACKAGE
- NO EXTERNAL COMPONENTS REQUIRED
- 4.5-9,9-18V,18-36V,36-72V,9-27V,18-54V,9-36V,18V-72V WIDE INPUT RANGE
- 100% BURN-IN
- HIGH EFFICIENCY
- UL 94V-0 PACKAGE MATERIAL
- CUSTOM SOLUTIONS AVAILABLE
- RoHS COMPLIANT
- 3 YEARS WARRANTY



OUTPUT SPECIFICATIONS

Voltage Set-point Accuracy	+/-2% max
Temperature Coefficient	+/-0.05%/°C
Ripple & Noise(20MHz BW) ¹	100mVp-p max
Line Regulation ²	+/-0.5% max
Load Regulation ³	+/-0.5% max
Minimum Load	10% of Full Load
Short Circuit Protection	Continuous
Short Circuit Restart	Automatic
Over Load Protection	180% Typ
Transient Response ⁵	200uS max

INPUT SPECIFICATIONS

Input Voltage Range	2:1 3:1 4:1 Input Range
Input Filter	Pi Network
Protection	Fuse Recommended

ENVIRONMENTAL SPECIFICATIONS

Operating Temperature	-25°C to +71°C
Storage Temperature	-55°C to +125°C
Humidity	95% max
Cooling	Free-Air Convection

GENERAL SPECIFICATIONS

Efficiency	70% min
Isolation Voltage ⁴	1500VDC or 3000VDC min
Isolation Resistance	10 ⁹ ohms min
Isolation Capacitance	120pF max
Switching Frequency	100 KHz min
MTBF ⁶	>670,000 Hours
Weight	31.2g Typ
Case Material ⁷	Six or Five-Side Shielded Case
Case Size	50.8mm*25.4mm*11.2mm
Potting Material	Epoxy(UL94V-0)
Conducted Emissions	EN55022 Class A
Radiated Emissions	EN55022 Class A

ALL SPECIFICATIONS TYPICAL AT NOMINAL LINE, FULL LOAD AND 25°C UNLESS OTHERWISE NOTED.

¹ Measured with 1uF ceramic capacitor connects to the output pins.

² High Line to Low Line.

³ Load Regulation is for output load current change from 10% to 100%.

⁴ 1500VDC for 10 seconds,2000VDC~3000VDC for 3 seconds.

⁵ 25% Step Load Change.

⁶ MIL-HDBK-217F @25 °C, Ground Benign.

⁷ Six-Side Shielded Case / Isolation Voltage=1500VDC.

Five-Side Shielded Case / Isolation Voltage=3000VDC.

DANUBE

<http://www.danube.com.tw>

1

2010/07/01

● **SELECTION GUIDE(1)**
2:1 5W OUTPUT

MODEL NUMBER	INPUT VOLTAGE (VDC)	OUTPUT VOLTAGE (VDC)	OUTPUT CURRENT (mA)	INPUT ⁸ CURRENT(mA)		EFF (%) ⁹	ISOLATION (VDC)
				FULL LOAD	NO LOAD		
LWS-0505H	4.5-9	5	900	1286	30	70	1500
LWS-0512H	4.5-9	12	417	1420	30	70	1500
LWS-0515H	4.5-9	15	333	1390	20	72	1500
LWD-0505H	4.5-9	+/-5	+/-450	1286	20	70	1500
LWD-0512H	4.5-9	+/-12	+/-208	1390	30	72	1500
LWD-0515H	4.5-9	+/-15	+/-167	1355	44	74	1500
LWS-1203.3H	9-18	3.3	1500	589	33	70	1500
LWS-1205H	9-18	5	1000	556	30	75	1500
LWS-1209H	9-18	9	556	520	30	80	1500
LWS-1212H	9-18	12	417	519	28	80	1500
LWS-1215H	9-18	15	333	514	28	81	1500
LWD-1205H	9-18	+/-5	+/-500	556	29	75	1500
LWD-1209H	9-18	+/-9	+/-278	525	28	79	1500
LWD-1212H	9-18	+/-12	+/-208	544	28	77	1500
LWD-1215H	9-18	+/-15	+/-167	520	28	80	1500
LWS-2403.3H	18-36	3.3	1500	290	16	71	1500
LWS-2405H	18-36	5	1000	270	14	77	1500
LWS-2409H	18-36	9	556	257	14	81	1500
LWS-2412H	18-36	12	417	254	13	82	1500
LWS-2415H	18-36	15	333	251	13	83	1500
LWS-2424H	18-36	24	208	260	21	80	1500
LWD-2405H	18-36	+/-5	+/-500	270	14	77	1500
LWD-2409H	18-36	+/-9	+/-278	257	14	81	1500
LWD-2412H	18-36	+/-12	+/-208	254	13	82	1500
LWD-2415H	18-36	+/-15	+/-167	251	12	83	1500
LWS-4803.3H	36-72	3.3	1500	135	10	77	1500
LWS-4805H	36-72	5	1000	135	8	77	1500
LWS-4809H	36-72	9	556	130	16	80	1500
LWS-4812H	36-72	12	417	126	7	83	1500
LWS-4815H	36-72	15	333	130	12	80	1500
LWD-4805H	36-72	+/-5	+/-500	135	8	77	1500
LWD-4809H	36-72	+/-9	+/-278	126	7	83	1500
LWD-4812H	36-72	+/-12	+/-208	126	7	83	1500
LWD-4815H	36-72	+/-15	+/-167	130	12	80	1500

⁸ NOMINAL INPUT VOLTAGE.

⁹ NOMINAL INPUT VOLTAGE, FULL LOAD.

● **SELECTION GUIDE(2)**
3:1 5W OUTPUT

MODEL NUMBER	INPUT VOLTAGE (VDC)	OUTPUT VOLTAGE (VDC)	OUTPUT CURRENT (mA)	INPUT ¹⁰ CURRENT(mA)		EFF (%) ¹¹	ISOLATION (VDC)
				FULL LOAD	NO LOAD		
LWS-1203.3HG	9-27	3.3	1500	555	20	75	1500
LWS-1205HG	9-27	5	1000	535	30	78	1500
LWS-1209HG	9-27	9	556	548	30	76	1500
LWS-1212HG	9-27	12	417	525	28	79	1500
LWS-1215HG	9-27	15	333	520	28	80	1500
LWD-1205HG	9-27	+/-5	+/-500	530	28	77	1500
LWD-1212HG	9-27	+/-12	+/-208	544	28	77	1500
LWD-1215HG	9-27	+/-15	+/-167	520	28	80	1500
LWS-2403.3HG	18-54	3.3	1500	277	14	75	1500
LWS-2405HG	18-54	5	1000	277	14	75	1500
LWS-2409HG	18-54	9	556	267	14	78	1500
LWS-2412HG	18-54	12	417	260	13	80	1500
LWS-2415HG	18-54	15	333	257	13	81	1500
LWD-2412HG	18-54	+/-12	+/-208	257	13	81	1500
LWD-2415HG	18-54	+/-15	+/-167	257	12	81	1500

Note: Other input to output voltages may be available. Please contact factory.

¹⁰ NOMINAL INPUT VOLTAGE.

¹¹ NOMINAL INPUT VOLTAGE, FULL LOAD.

● **SELECTION GUIDE(3)**
4:1 5W OUTPUT

MODEL NUMBER	INPUT VOLTAGE (VDC)	OUTPUT VOLTAGE (VDC)	OUTPUT CURRENT (mA)	INPUT ¹² CURRENT(mA)		EFF (%) ¹³	ISOLATION (VDC)
				FULL LOAD	NO LOAD		
LWS-1203.3HT	9-36	3.3	1500	555	20	75	1500
LWS-1205HT	9-36	5	1000	535	30	78	1500
LWS-1209HT	9-36	9	556	548	30	76	1500
LWS-1212HT	9-36	12	417	541	28	77	1500
LWS-1215HT	9-36	15	333	541	28	77	1500
LWD-1205HT	9-36	+/-5	+/-500	530	28	77	1500
LWD-1212HT	9-36	+/-12	+/-208	544	28	77	1500
LWD-1215HT	9-36	+/-15	+/-167	541	28	77	1500
LWS-2403.3HT	18-72	3.3	1500	277	14	75	1500
LWS-2405HT	18-72	5	1000	277	14	75	1500
LWS-2409HT	18-72	9	556	267	14	78	1500
LWS-2412HT	18-72	12	417	260	13	80	1500
LWS-2415HT	18-72	15	333	257	13	81	1500
LWD-2412HT	18-72	+/-12	+/-208	257	13	81	1500
LWD-2415HT	18-72	+/-15	+/-167	257	12	81	1500

Note: Other input to output voltages may be available. Please contact factory.

¹² NOMINAL INPUT VOLTAGE.

¹³ NOMINAL INPUT VOLTAGE, FULL LOAD.

● **SELECTION GUIDE(4)**
2:1 5W OUTPUT

MODEL NUMBER	INPUT VOLTAGE (VDC)	OUTPUT VOLTAGE (VDC)	OUTPUT CURRENT (mA)	INPUT ¹⁴ CURRENT(mA)		EFF (%) ¹⁵	ISOLATION (VDC)
				FULL LOAD	NO LOAD		
LWS-0512H-3K	4.5-9	12	417	1420	30	70	3000
LWS-0515H-3K	4.5-9	15	333	1390	20	72	3000
LWD-0515H-3K	4.5-9	+/-15	+/-167	1355	44	74	3000
LWS-1203.3H-3K	9-18	3.3	1500	589	33	70	3000
LWS-1205H-3K	9-18	5	1000	556	30	75	3000
LWS-1209H-3K	9-18	9	556	520	30	80	3000
LWS-1212H-3K	9-18	12	417	519	28	80	3000
LWS-1215H-3K	9-18	15	333	514	28	81	3000
LWD-1205H-3K	9-18	+/-5	+/-500	556	29	75	3000
LWD-1209H-3K	9-18	+/-9	+/-278	525	28	79	3000
LWD-1212H-3K	9-18	+/-12	+/-208	544	28	77	3000
LWD-1215H-3K	9-18	+/-15	+/-167	520	28	80	3000
LWS-2403.3H-3K	18-36	3.3	1500	290	16	71	3000
LWS-2405H-3K	18-36	5	1000	270	14	77	3000
LWS-2409H-3K	18-36	9	556	257	14	81	3000
LWS-2412H-3K	18-36	12	417	254	13	82	3000
LWS-2415H-3K	18-36	15	333	251	13	83	3000
LWD-2405H-3K	18-36	+/-5	+/-500	270	14	77	3000
LWD-2409H-3K	18-36	+/-9	+/-278	257	14	81	3000
LWD-2412H-3K	18-36	+/-12	+/-208	254	13	82	3000
LWD-2415H-3K	18-36	+/-15	+/-167	251	12	83	3000
LWS-4803.3H-3K	36-72	3.3	1500	135	10	77	3000
LWS-4805H-3K	36-72	5	1000	135	8	77	3000
LWS-4809H-3K	36-72	9	556	132	8	79	3000
LWS-4812H-3K	36-72	12	417	126	7	83	3000
LWS-4815H-3K	36-72	15	333	130	12	80	3000
LWD-4805H-3K	36-72	+/-5	+/-500	135	8	77	3000
LWD-4809H-3K	36-72	+/-9	+/-278	126	7	83	3000
LWD-4812H-3K	36-72	+/-12	+/-208	126	7	83	3000
LWD-4815H-3K	36-72	+/-15	+/-167	130	12	80	3000

Note: Other input to output voltages may be available. Please contact factory.

¹⁴ NOMINAL INPUT VOLTAGE.

¹⁵ NOMINAL INPUT VOLTAGE, FULL LOAD.

● **SELECTION GUIDE(5)**
4:1 5W OUTPUT

MODEL NUMBER	INPUT VOLTAGE (VDC)	OUTPUT VOLTAGE (VDC)	OUTPUT CURRENT (mA)	INPUT ¹⁶ CURRENT(mA)		EFF (%) ¹⁷	ISOLATION (VDC)
				FULL LOAD	NO LOAD		
LWS-1203.3HT-3K	9-36	3.3	1500	555	20	75	3000
LWS-1205HT-3K	9-36	5	1000	535	30	78	3000
LWS-1209HT-3K	9-36	9	556	548	30	76	3000
LWS-1212HT-3K	9-36	12	417	525	28	79	3000
LWS-1215HT-3K	9-36	15	333	520	28	80	3000
LWD-1205HT-3K	9-36	+/-5	+/-500	530	28	77	3000
LWD-1212HT-3K	9-36	+/-12	+/-208	544	28	77	3000
LWD-1215HT-3K	9-36	+/-15	+/-167	520	28	80	3000
LWS-2403.3HT-3K	18-72	3.3	1500	277	14	75	3000
LWS-2405HT-3K	18-72	5	1000	277	14	75	3000
LWS-2409HT-3K	18-72	9	556	267	14	78	3000
LWS-2412HT-3K	18-72	12	417	260	13	80	3000
LWS-2415HT-3K	18-72	15	333	257	13	81	3000
LWD-2412HT-3K	18-72	+/-12	+/-208	257	13	81	3000
LWD-2415HT-3K	18-72	+/-15	+/-167	257	12	81	3000

Note: Other input to output voltages may be available. Please contact factory.

¹⁶ NOMINAL INPUT VOLTAGE.

¹⁷ NOMINAL INPUT VOLTAGE, FULL LOAD.

● SIMPLIFIED SCHEMATIC

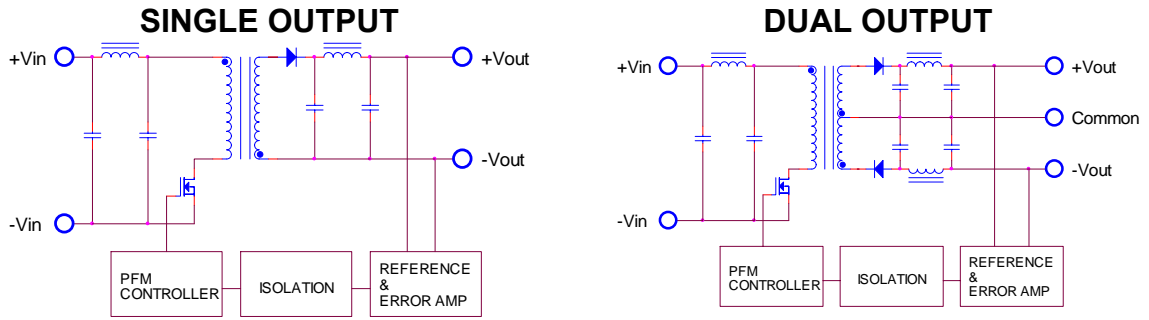

● MECHANICAL DIMENSIONS & RECOMMENDED FOOTPRINT DETAILS

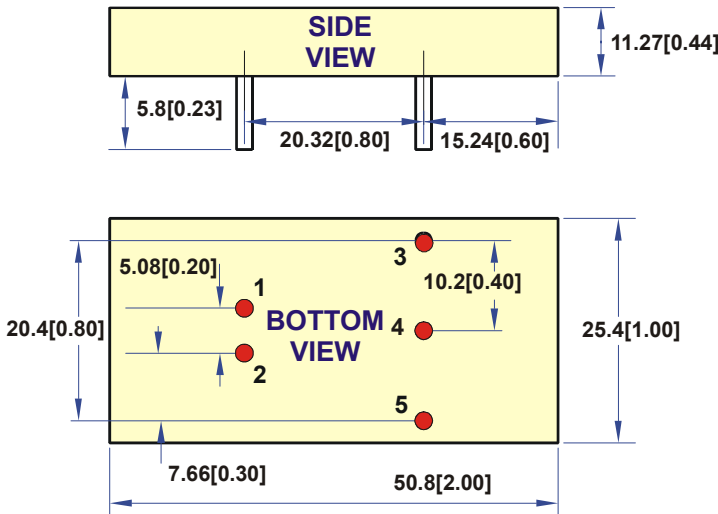

PIN	SINGLE	DUAL
1	+Vin	+Vin
2	-Vin	-Vin
3	+Vout	+Vout
4	NO PIN	Common
5	-Vout	-Vout

NOTE: Pin Size is Tolerance $0.8\Phi \pm 0.10\text{mm}$

NOTE: Pin Size is Tolerance $1.0\Phi \pm 0.10\text{mm}$

All Dimensions In mm(Inches)

Tolerance .X or .XX = $\pm 0.80\text{mm}$

All dimensions are in millimeters[inches]

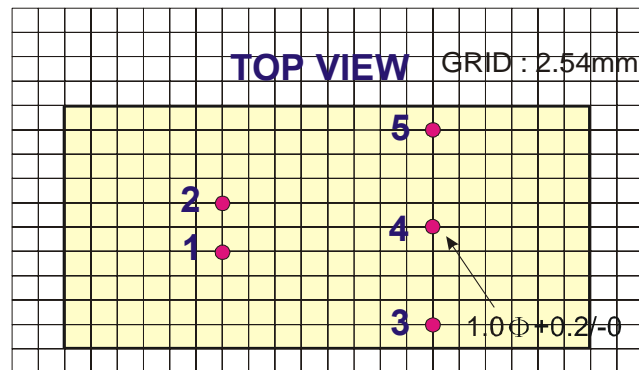

● TYPICAL APPLICATIONS

SINGLE OUTPUT

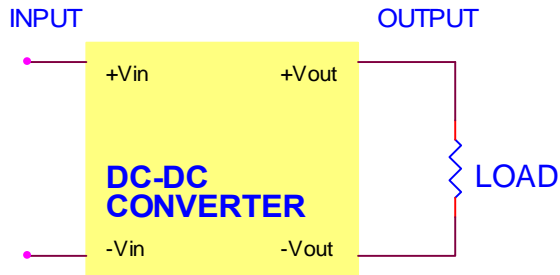

DUAL OUTPUT

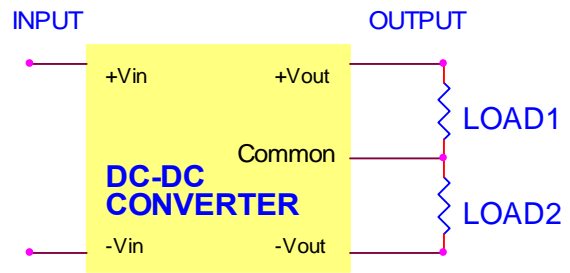

● TYPICAL PERFORMANCE CURVES

Specifications typical at $T_a=25^\circ\text{C}$, nominal input voltage, rated output current unless otherwise specified.

OUTPUT LOAD VS EFFICIENCY

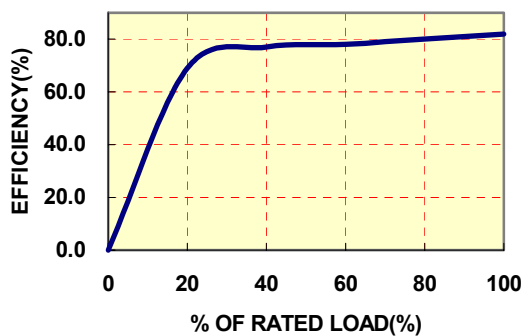

TEMPERATURE DERATING

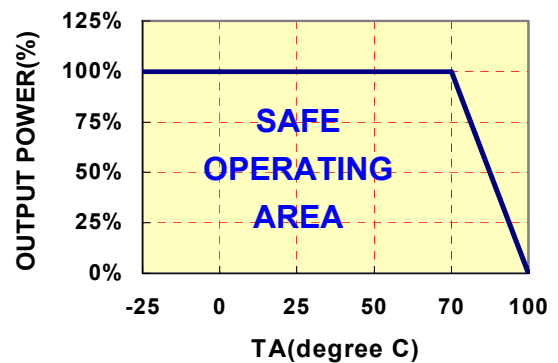

● INPUT FUSE SELECTION GUIDE

4.5-9V INPUT VOLTAGE(VDC)	9-18V or 9-27V or 9-36V INPUT VOLTAGE(VDC)	18-36V or 18-54V or 18-72V INPUT VOLTAGE(VDC)	36-72V INPUT VOLTAGE(VDC)
2500mA Slow-Blow Type	900mA Slow-Blow Type	500mA Slow-Blow Type	250mA Slow-Blow Type

Note: Certain applications may require the installation of external fuse in front of the input.

LW SERIES APPLICATION NOTES:

EXTERNAL CAPACITANCE REQUIREMENTS:

No external capacitance is required for operation of the LW series.

To meet the reflected ripple requirements of the converter, an input impedance of less than 0.5 ohm from DC to 100KHz is required.

External output capacitance is not required for operation, however it is recommended that 10uF tantalum and 0.1uF ceramic capacitance be selected for reduced system noise.

Additional output capacitance may be added for increased filtering, but should not exceed 1000uF.

We Can Offer EMC-Filter According To EN55011/22 Class B

Negative Outputs:

A negative output voltage may be obtained by connecting the +OUT to circuit ground and connecting -OUT as the negative output.

FOR MORE INFORMATION CALL:

Danube Enterprise Co., Ltd.

Tel: 886-7-3755165

Fax: 886-7-3755330

E-mail: danube@ms10.hinet.net

Home Page

<http://www.danube.com.tw>
