

SERIES: VF-S320-XXA-CFS | **DESCRIPTION:** AC-DC POWER SUPPLY

FEATURES

- up to 320 W continuous power
- 700 W peak power within 500 μ s duty duration
- metal top cover and side fan
- passive power factor correction
- power good signal
- 3,000 Vac isolation voltage
- over load, over voltage, over temperature, and short circuit protections
- UL, cUL, and TUV 60950-1 safety approvals
- efficiency up to 83%



MODEL	output voltage	output current	output ¹ power	ripple and noise ^{2,3}	efficiency
	(Vdc)	max (A)	max (W)	max (mVp-p)	typ (%)
VF-S320-05A-CFS	5	45	225	50	75%
VF-S320-09A-CFS	9	29.1	262	90	83%
VF-S320-12A-CFS	12	26.67	320	120	80%
VF-S320-15A-CFS	15	21.33	320	150	83%
VF-S320-18A-CFS	18	17.78	320	180	83%
VF-S320-24A-CFS	24	13.33	320	240	83%
VF-S320-28A-CFS	28	11.43	320	280	83%
VF-S320-36A-CFS	36	8.89	320	360	83%
VF-S320-48A-CFS	48	6.67	320	480	83%
VF-S320-54A-CFS	54	5.93	320	540	83%

Notes: 1. 1% minimum load is required to maintain the ripple and regulation.
 2. Ripple and noise is measured from 10 KHz to 20 MHz at output terminals with a 0.1 μ F ceramic capacitor and a 22 μ F electrolytic capacitor in parallel.

PART NUMBER KEY

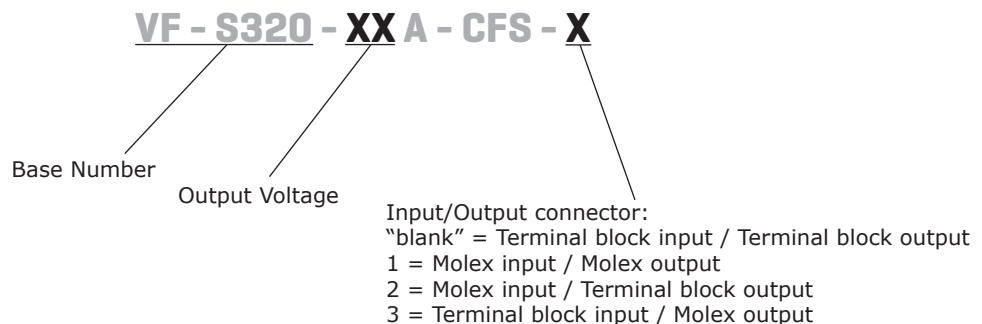

INPUT

parameter	conditions/description	min	typ	max	units
voltage	90-132/180-264 auto selectable	90/180		132/264	Vac
frequency		47		63	Hz
current	at 100~120 Vac, cold start at 200~240 Vac, cold start			8 4	A A
inrush current	at 115 Vac, full load, cold start at 230 Vac, full load, cold start			35 70	A A
power factor	compliant to EN 61000-3-2 class A				

OUTPUT

parameter	conditions/description	min	typ	max	units
line regulation	low line to high line		±1		%
load regulation	all other outputs		±1		%
temperature coefficient			0.25		mV/°C
transient response	Output voltage returns to within 1% in less than 2.5 ms for a 50% load change. Peak transient does not exceed 5%.				
start-up time	at 120 Vac			1	s
rise time		0.2		20	ms
hold-up time	at 120 Vac and 80% of rated maximum load	20			ms
adjustability			±5		%
power good	Designated as PG on the CN1. This signal goes high 100-500 mS after the output reaches regulation. It goes low at least 1 mS before loss of regulation.				
fan drive	12 Vdc / 300 mA for external fan				

PROTECTIONS

parameter	conditions/description	min	typ	max	units
over voltage protection	AC input needs to be reset to restart the power supply.			130	%
over current protection	automatically recovers		110	140	%
short circuit protection	short circuit can be continuous, recovers automatically upon removal of short				
over temperature protection	auto recovery			85	°C

SAFETY & COMPLIANCE

parameter	conditions/description	min	typ	max	units
isolation voltage	applied for 3 seconds at 10 mA max. primary to secondary primary to transformer core primary to earth chassis	3,000 1,500 1,500			Vac Vac Vac
safety approvals	UL 60950-1, CSA C22.2 No. 60950-1-03, TUV EN 60950-1, CE Mark (LVD) EN 61000-3-(2,3) & IEC 61000-4 Series regulations and CB				
EMI/EMC	pass FCC Part 15, CISPR 22 class B, conducted				
leakage current	at 240 Vac at 120 Vac			500 300	µA µA
RoHS compliant	yes				
MTBF	according to MIL-HDBK-217 at 30 °C	100,000			hrs

ENVIRONMENTAL

parameter	conditions/description	min	typ	max	units
operating temperature	see derating curve	0		70	°C
storage temperature		-20		85	°C
operating humidity	non-condensing	5%		90%	%
storage humidity	non-condensing	5%		95%	%
vibration	acceleration $\pm 7.35 M/(S \times S)$, on X, Y and Z Axis	5		50	Hz

DERATING CURVES

output power vs. ambient temperature

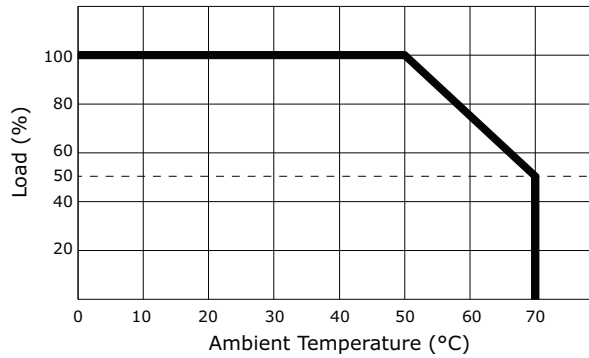

MECHANICAL

parameter	conditions/description	min	typ	max	units
dimensions	177.80 x 101.60 x 39.30 [7 x 4 x 1.6 inch]				mm
weight				750	g

MECHANICAL DRAWING

units: mm[inches]
 tolerance: ±0.3 mm
 unless otherwise specified

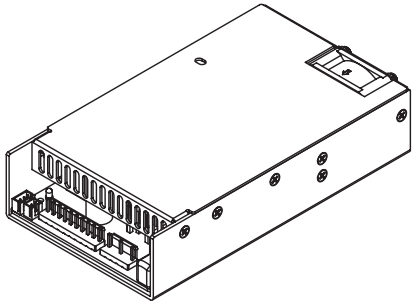

SCALE: 1:3

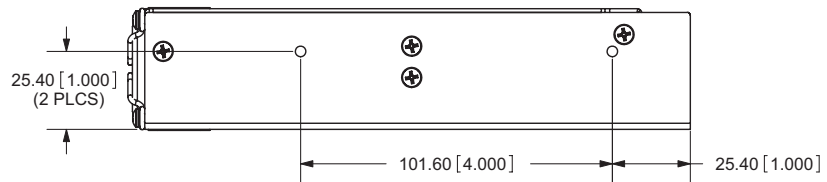

CN1	
1	ground
2	ac neutral
3	ac line

CN2	
1	Vo+
2	Vo+
3	Vo+
4	Vo+
5	Vo+
6	Vo-
7	Vo-
8	Vo-
9	Vo-
10	Vo-

CN3	
1	power good
2	RTN
3	fan fail

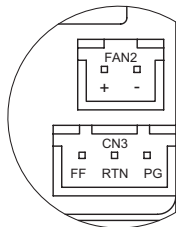

DETAIL A
 SCALE 2 : 1

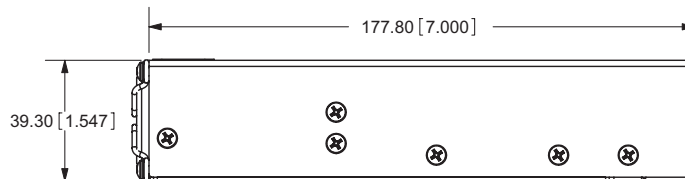
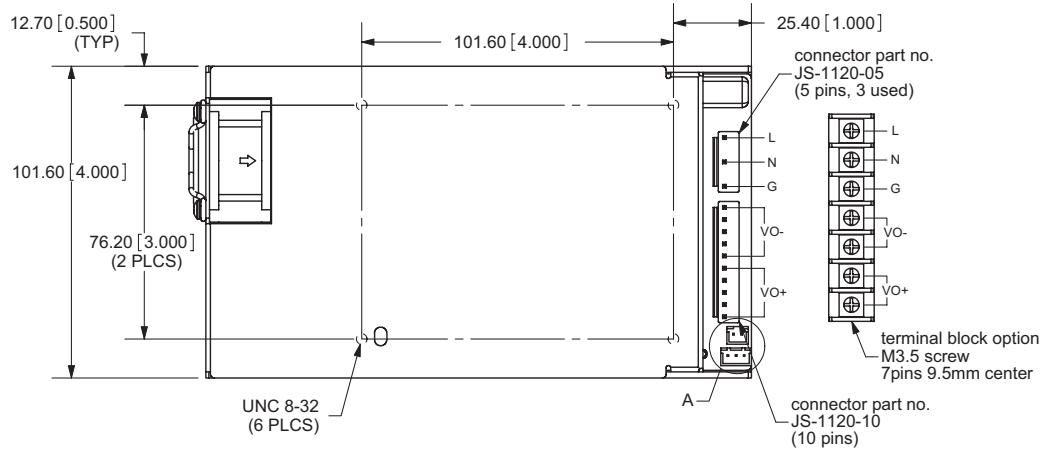

- Notes:
1. CN1 mates with JST VH series 5-pin connector.
 2. CN2 mates with VH series 10-pin connector.
 3. CN3 mates with JST XHP-3 or equivalent (CHYAO SHIUNN JS-2001-03) and JST SXH-002T-P0.6 mating pins
 4. Fan drive connector mates with JST part no. XHP-2 or equivalent
 5. Mounting hole max depth 4.00mm

REVISION HISTORY

rev.	description	date
1.0	initial release	05/5/2009
1.01	new template applied	12/17/2011
1.02	V-Infinity branding removed	08/28/2012
1.03	removed on/off information, removed low leakage option, updated spec	04/23/2013

The revision history provided is for informational purposes only and is believed to be accurate.



Headquarters
20050 SW 112th Ave.
Tualatin, OR 97062
800.275.4899

Fax 503.612.2383
cui.com
techsupport@cui.com

CUI offers a two (2) year limited warranty. Complete warranty information is listed on our website.

CUI reserves the right to make changes to the product at any time without notice. Information provided by CUI is believed to be accurate and reliable. However, no responsibility is assumed by CUI for its use, nor for any infringements of patents or other rights of third parties which may result from its use.

CUI products are not authorized or warranted for use as critical components in equipment that requires an extremely high level of reliability. A critical component is any component of a life support device or system whose failure to perform can be reasonably expected to cause the failure of the life support device or system, or to affect its safety or effectiveness.