

SERIES: VQA | **DESCRIPTION:** DC-DC CONVERTER

FEATURES

- designed for IGBT driver modules
- small footprint
- 3,000 Vac isolation
- short circuit protection
- temperature range (-40~105°C)
- UL 60950-1 approval
- efficiency up to 80%



MODEL

| MODEL | input voltage | | output voltage (Vdc) | output current max (mA) | ripple and noise ² max (mVp-p) | efficiency ³ typ (%) |
|------------------------------|---------------|----------------|-------------------------|-------------------------------|---|---------------------------------------|
| | typ (Vdc) | range (Vdc) | | | | |
| VQA-S9-D15-SIP ¹ | 12 | 9~15 | 15 -8 | 100 -80 | 200 | 80 |
| VQA-S12-D15-SIP ¹ | 12 | 11.6~12.4 | 15 -8.7 | 80 -40 | 200 | 80 |
| VQA-S15-S9-SIP | 15 | 14.5~15.5 | 9 | 111 | 200 | 80 |
| VQA-S15-D9-SIP | 15 | 14.5~15.5 | 9 -9 | 55 -55 | 200 | 80 |
| VQA-S15-D15-SIP ¹ | 15 | 14.5~15.5 | 15 -8.7 | 80 -40 | 200 | 80 |
| VQA-S15-D17-SIP ¹ | 15 | 14.5~15.5 | 17 -8.7 | 80 -40 | 200 | 80 |
| VQA-S24-D15-SIP ¹ | 24 | 23.3~24.7 | 15 -8.7 | 80 -40 | 200 | 80 |

Notes: 1. UL approved
 2. Ripple and noise are measured at 20 MHz BW by "parallel cable" method with 1 μF ceramic and 10 μF electrolytic capacitors on the output.
 3. at full load

PART NUMBER KEY

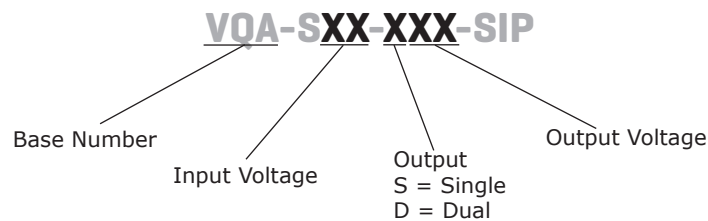

INPUT

| parameter | conditions/description | min | typ | max | units |
|-------------------------|------------------------|------|-----|-------|-------|
| input voltage | VQA-S9-D15-SIP | 9 | 12 | 15 | Vdc |
| | VQA-S12-D15-SIP | 11.6 | 12 | 12.4 | Vdc |
| | VQA-S24-D15-SIP | 23.3 | 24 | 24.7 | Vdc |
| | all other models | 14.5 | 15 | 15.5 | Vdc |
| surge voltage | VQA-S9-D15-SIP | -0.7 | | 15 | Vdc |
| | VQA-S12-D15-SIP | -0.7 | | 13 | Vdc |
| | VQA-S24-D15-SIP | -0.7 | | 26 | Vdc |
| | all other models | -0.7 | | 16 | Vdc |
| temperature coefficient | at full load | | | ±0.03 | %/°C |

OUTPUT

| parameter | conditions/description | min | typ | max | units |
|---------------------|-----------------------------|-----|-----|-----|-------|
| capacitive load | | | | 200 | μF |
| line regulation | for Vin change of ±1% | | 1.2 | 1.5 | % |
| switching frequency | at full load, nominal input | | 100 | 200 | kHz |

PROTECTIONS

| parameter | conditions/description | min | typ | max | units |
|---------------------------------------|------------------------|-----|-----|-----|-------|
| short circuit protection ¹ | | | | 1 | s |

Notes: 1. The supply voltage must be discontinued at the end of the short circuit duration

SAFETY AND COMPLIANCE

| parameter | conditions/description | min | typ | max | units |
|-------------------------------|--|-----------|-----|-----|-------|
| isolation voltage | input to output for 1 minute at 1 mA max. leakage | 3,000 | | | Vac |
| isolation resistance | input to output at 500 Vdc | 1,000 | | | MΩ |
| isolation capacitance | input to output, 100 kHz/0.1 V | | 6.6 | | pF |
| safety approvals ² | UL 60950-1 | | | | |
| conducted emissions | CISPR22/EN55022, class B, external circuit required (see figure 1) | | | | |
| radiated emissions | CISPR22/EN55022, class B, external circuit required (see figure 1) | | | | |
| ESD | IEC/EN61000-4-2, contact ±8kV, class B | | | | |
| MTBF | as per MIL-HDBK-217F @ 25°C | 3,500,000 | | | hours |
| RoHS | 2011/65/EU | | | | |

Notes: 2. See specific models listed on page 1

ENVIRONMENTAL

| parameter | conditions/description | min | typ | max | units |
|-----------------------|------------------------|-----|-----|-----|-------|
| operating temperature | see derating curve | -40 | | 105 | °C |
| storage temperature | | -55 | | 125 | °C |
| storage humidity | non-condensing | | | 95 | % |

SOLDERABILITY

| parameter | conditions/description | min | typ | max | units |
|----------------|--------------------------------|-----|-----|-----|-------|
| hand soldering | 1.5mm from case for 10 seconds | | | 300 | °C |

MECHANICAL

| parameter | conditions/description | min | typ | max | units |
|------------------|--|-----|-----|-----|-------|
| dimensions | 19.50 x 9.80 x 12.5 (0.768 x 0.386 x 0.492 inch) | | | | mm |
| material | plastic (UL94V-0) | | | | |
| weight | | | 4.3 | | g |
| temperature rise | Ta=25°C | | 25 | | °C |

MECHANICAL DRAWING

units: mm [inches]
 tolerance: ±0.50 [±0.020]
 pin section tolerance: ±0.10 [±0.004]

| PIN CONNECTIONS | |
|-----------------|----------|
| PIN | FUNCTION |
| 1 | Vin |
| 2 | GND |
| 5* | -Vo |
| 6 | 0 V |
| 7 | +Vo |

Note: *VQA-S15-S9-SIP has no connection

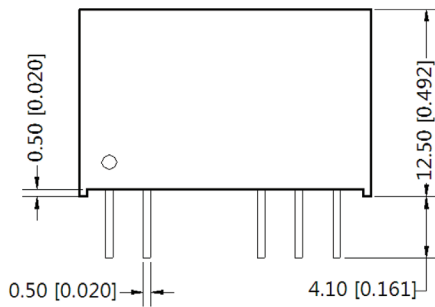

Front View

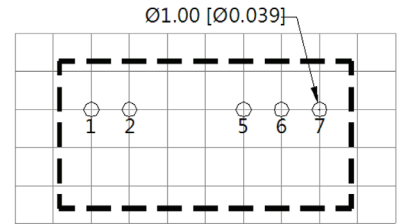

Grid size: 2.54mm x 2.54mm

Top View
PCB LAYOUT

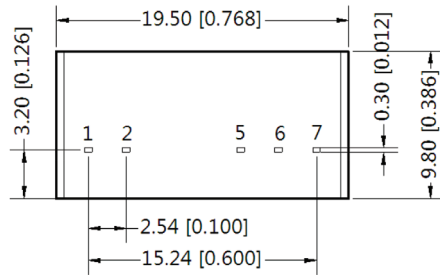

Bottom View

DERATING CURVES

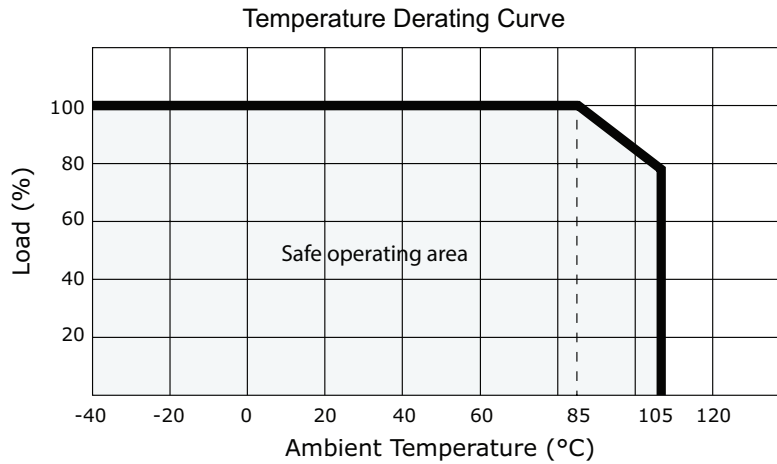

PERFORMANCE CURVES

1. output current vs. efficiency

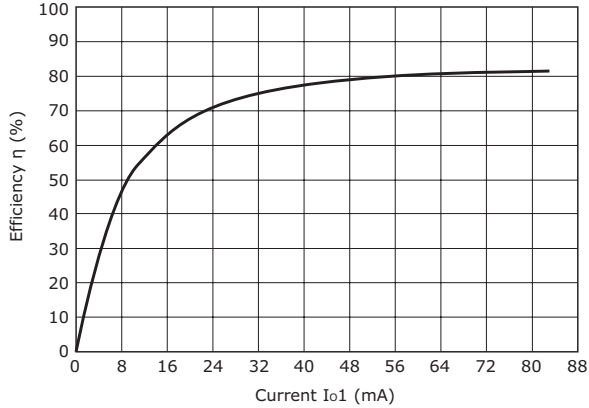

VQA-S12-D15-SIP, VQA-S15-D15-SIP, VQA-S24-D15-SIP

2. output current vs. output voltage

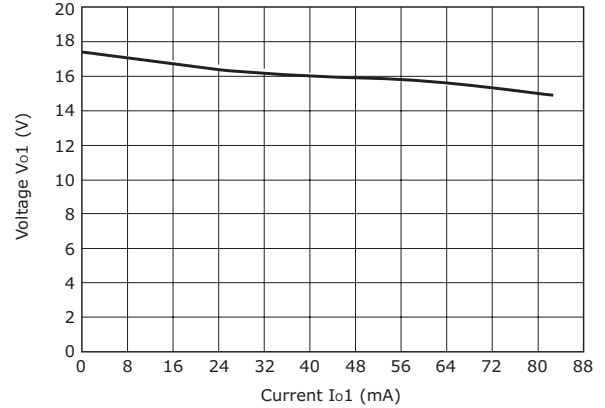

VQA-S12-D15-SIP, VQA-S15-D15-SIP, VQA-S24-D15-SIP

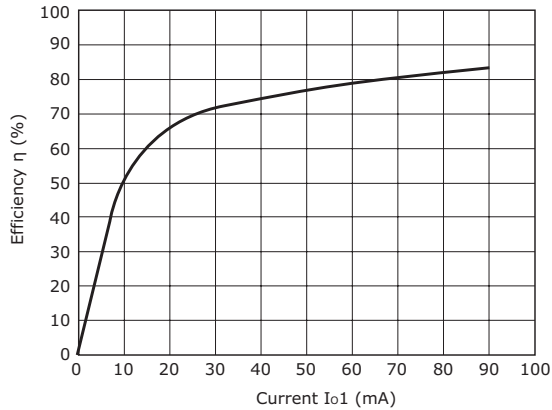

VQA-S15-D17-SIP

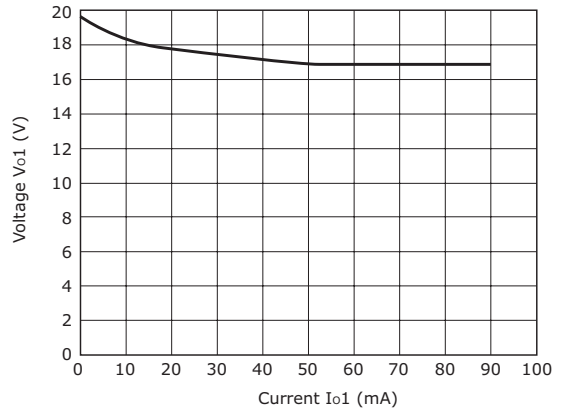

VQA-S15-D17-SIP

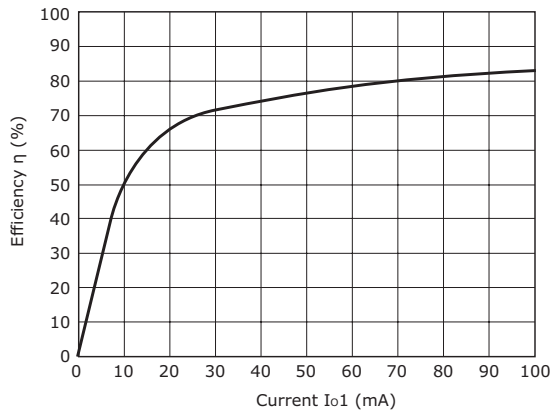

VQA-S9-D15-SIP

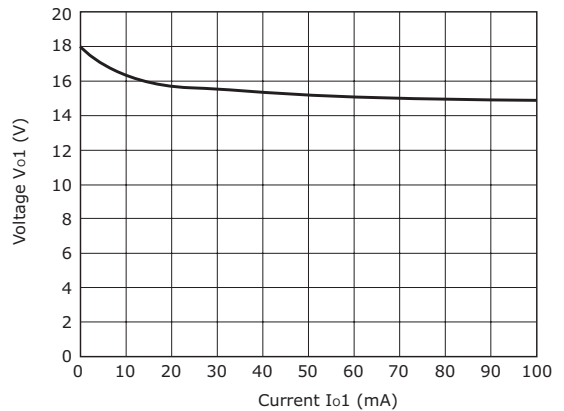

VQA-S9-D15-SIP

PERFORMANCE CURVES (CONTINUED)

1. output current vs. efficiency



VQA-S15-S9-SIP

2. output current vs. output voltage

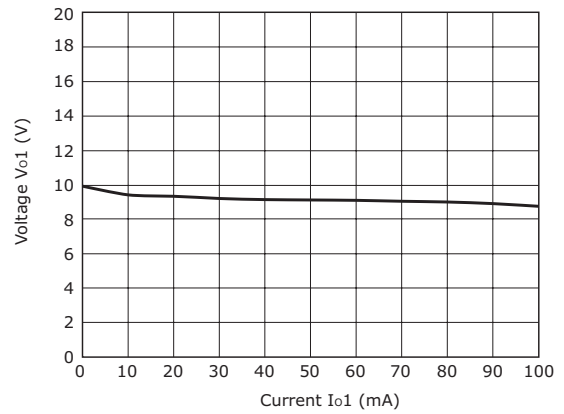

VQA-S15-S9-SIP

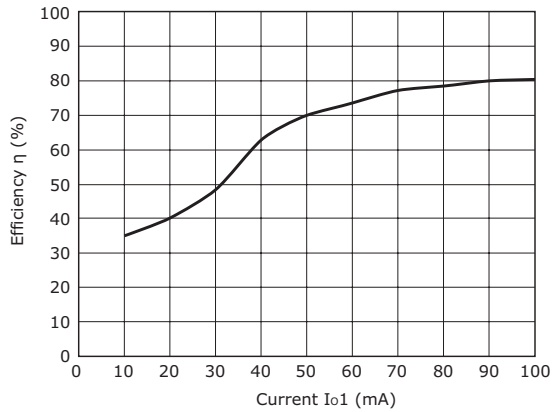

VQA-S15-D9-SIP

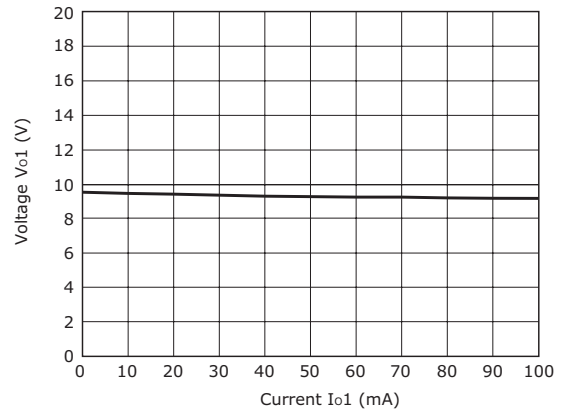

VQA-S15-D9-SIP

EMC RECOMMENDED CIRCUIT



Figure 1

Table 1

| Recommended external circuit components | | |
|---|-----------------|------------|
| V_{in} (Vdc) | C1 | LDM |
| 12 | 4.7 μ F/50V | 12 μ H |
| 15 | 4.7 μ F/50V | 12 μ H |
| 24 | 4.7 μ F/50V | 12 μ H |

TEST CONFIGURATION

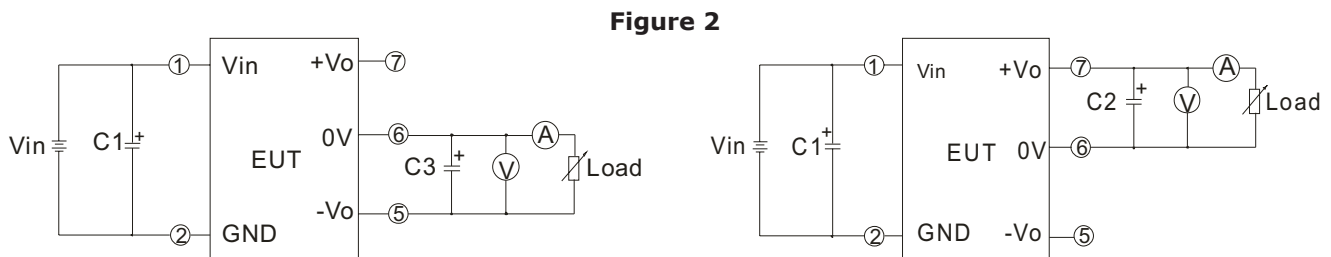
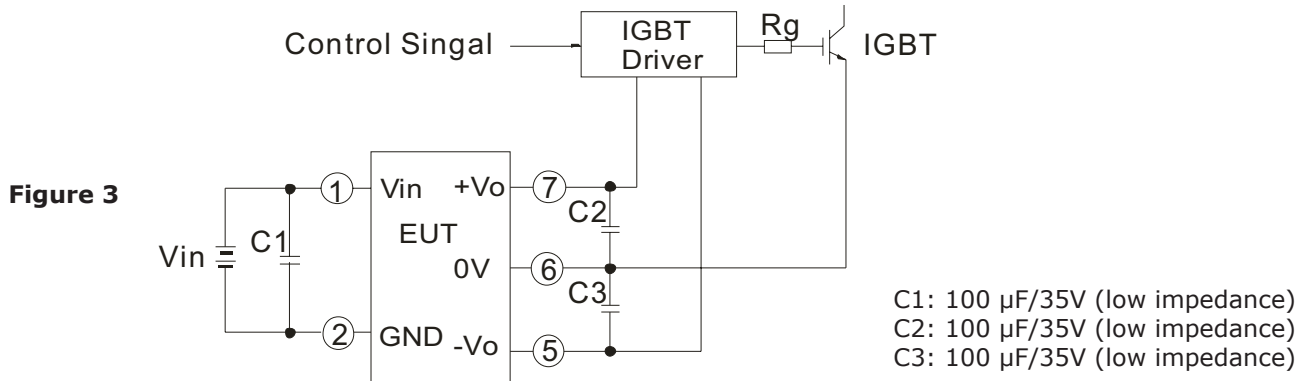

Figure 2

C1, C2, C3: 100 μ F/35V (low impedance)

APPLICATION CIRCUIT



- Notes:
1. The wire between the converter and IGBT driver must as short as possible.
 2. External filter capacitors should be connected as close as possible to the converter and the IGBT driver.
 3. The output average power of the IGBT driver should be less than the output power of DC-DC module.
 4. Maximum capacitive load is tested at nominal input voltage and full load.

Note: 1. All specifications are measured at $T_a=25^\circ\text{C}$, humidity <75%, nominal input voltage and rated output load unless otherwise specified.

REVISION HISTORY

| rev. | description | date |
|------|-----------------------------------|------------|
| 1.0 | initial release | 08/16/2012 |
| 1.01 | updated features | 09/20/2012 |
| 1.02 | updated product photograph | 11/13/2012 |
| 1.03 | various updates | 02/05/2013 |
| 1.04 | added switching frequency to spec | 07/01/2013 |
| 1.05 | added models, updated spec | 09/23/2013 |
| 1.06 | added UL to some models | 02/12/2015 |

The revision history provided is for informational purposes only and is believed to be accurate.



CUI INC[®]

Headquarters
20050 SW 112th Ave.
Tualatin, OR 97062
800.275.4899

Fax 503.612.2383
cui.com
techsupport@cui.com

CUI offers a two (2) year limited warranty. Complete warranty information is listed on our website.

CUI reserves the right to make changes to the product at any time without notice. Information provided by CUI is believed to be accurate and reliable. However, no responsibility is assumed by CUI for its use, nor for any infringements of patents or other rights of third parties which may result from its use.

CUI products are not authorized or warranted for use as critical components in equipment that requires an extremely high level of reliability. A critical component is any component of a life support device or system whose failure to perform can be reasonably expected to cause the failure of the life support device or system, or to affect its safety or effectiveness.