

**SERIES:** PDS1-M | **DESCRIPTION:** DC-DC CONVERTER

**FEATURES**

- 1 W isolated output
- smaller package
- single and dual unregulated outputs
- 1,500 Vdc isolation
- short circuit protection
- extended temperature range (-40~105°C)
- antistatic protection up to 8kV
- high efficiency at light load
- efficiency up to 82%



MODEL	input voltage		output voltage (Vdc)	output current		output power max (W)	ripple and noise <sup>2</sup> typ (mVp-p)	efficiency typ (%)
	typ (Vdc)	range (Vdc)		min (mA)	max (mA)			
PDS1-S3-S3-M	3.3	2.97~3.63	3.3	30	303	1	30	72
PDS1-S3-S5-M <sup>1</sup>	3.3	2.97~3.63	5	20	200	1	30	74
PDS1-S3-D5-M	3.3	2.97~3.63	±5	±10	±100	1	60	78
PDS1-S3-D12-M	3.3	2.97~3.63	±12	±5	±42	1	60	78
PDS1-S3-D15-M	3.3	2.97~3.63	±15	±3	±33	1	60	78
PDS1-S5-S3-M <sup>1</sup>	5	4.5~5.5	3.3	30	303	1	30	74
PDS1-S5-S5-M <sup>1</sup>	5	4.5~5.5	5	20	200	1	30	80
PDS1-S5-S9-M <sup>1</sup>	5	4.5~5.5	9	12	111	1	30	80
PDS1-S5-S12-M <sup>1</sup>	5	4.5~5.5	12	9	84	1	30	80
PDS1-S5-S15-M <sup>1</sup>	5	4.5~5.5	15	7	67	1	60	80
PDS1-S5-S24-M <sup>1</sup>	5	4.5~5.5	24	4	42	1	60	80
PDS1-S5-D5-M	5	4.5~5.5	±5	±10	±100	1	60	80
PDS1-S5-D9-M	5	4.5~5.5	±9	±6	±56	1	60	80
PDS1-S5-D12-M	5	4.5~5.5	±12	±5	±42	1	60	81
PDS1-S5-D15-M	5	4.5~5.5	±15	±3	±33	1	60	81
PDS1-S5-D24-M	5	4.5~5.5	±24	±2	±21	1	60	81
PDS1-S12-S3-M <sup>1</sup>	12	10.8~13.2	3.3	30	303	1	30	74
PDS1-S12-S5-M <sup>1</sup>	12	10.8~13.2	5	20	200	1	30	80
PDS1-S12-S9-M <sup>1</sup>	12	10.8~13.2	9	12	111	1	30	80
PDS1-S12-S12-M <sup>1</sup>	12	10.8~13.2	12	9	84	1	30	81
PDS1-S12-S15-M <sup>1</sup>	12	10.8~13.2	15	7	67	1	60	81
PDS1-S12-D5-M	12	10.8~13.2	±5	±10	±100	1	60	80
PDS1-S12-D9-M	12	10.8~13.2	±9	±6	±56	1	60	80
PDS1-S12-D12-M	12	10.8~13.2	±12	±5	±42	1	60	81
PDS1-S12-D15-M	12	10.8~13.2	±15	±3	±33	1	60	81
PDS1-S12-D24-M	12	10.8~13.2	±24	±2	±21	1	60	81
PDS1-S15-S15-M	15	13.5~16.5	15	7	67	1	60	81
PDS1-S24-S5-M <sup>1</sup>	24	21.6~26.4	5	20	200	1	30	80

**MODEL  
(CONTINUED)**

	input voltage		output voltage	output current		output power	ripple and noise <sup>2</sup>	efficiency
	typ (Vdc)	range (Vdc)	(Vdc)	min (mA)	max (mA)	max (W)	typ (mVp-p)	typ (%)
PDS1-S24-S9-M <sup>1</sup>	24	21.6~26.4	9	12	111	1	30	80
PDS1-S24-S12-M	24	21.6~26.4	12	9	84	1	30	80
PDS1-S24-S15-M <sup>1</sup>	24	21.6~26.4	15	7	67	1	60	81
PDS1-S24-S24-M <sup>1</sup>	24	21.6~26.4	24	4	42	1	60	81
PDS1-S24-D5-M	24	21.6~26.4	±5	±10	±100	1	60	80
PDS1-S24-D9-M	24	21.6~26.4	±9	±6	±56	1	60	80
PDS1-S24-D12-M	24	21.6~26.4	±12	±5	±42	1	60	81
PDS1-S24-D15-M	24	21.6~26.4	±15	±3	±33	1	60	82
PDS1-S24-D24-M	24	21.6~26.4	±24	±2	±21	1	60	82

Notes: 1. UL approved  
2. Ripple and noise are measured at 20 MHz BW by "parallel cable" method with 1 µF ceramic and 10 µF electrolytic capacitors on the output.

**PART NUMBER KEY**

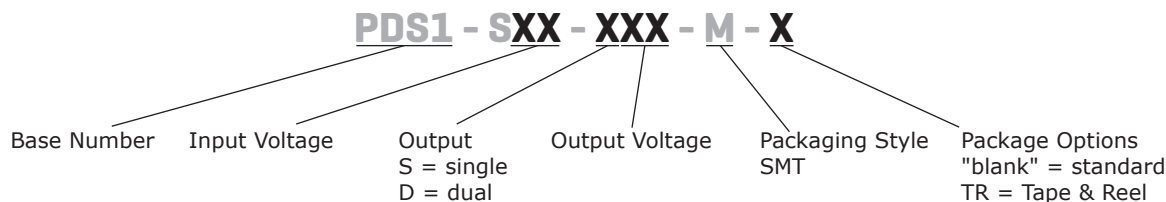

**INPUT**

parameter	conditions/description	min	typ	max	units
operating input voltage	3.3 Vdc input models	2.97	3.3	3.63	Vdc
	5 Vdc input models	4.5	5	5.5	Vdc
	12 Vdc input models	10.8	12	13.2	Vdc
	15 Vdc input models	13.5	15	16.5	Vdc
	24 Vdc input models	21.6	24	26.4	Vdc
surge voltage	for maximum of 1 second				
	3.3 Vdc input models	-0.7		5	Vdc
	5 Vdc input models	-0.7		9	Vdc
	12 Vdc input models	-0.7		18	Vdc
	15 Vdc input models	-0.7		21	Vdc
	24 Vdc input models	-0.7		30	Vdc
filter	capacitance filter				

**OUTPUT**

parameter	conditions/description	min	typ	max	units
line regulation	for Vin change of 1%				
	3.3 Vdc output models			±1.5	%
	all other models			±1.2	%
load regulation	measured from 10% load to full load				
	3.3 Vdc output models		18		%
	5 Vdc output models		12		%
	9 Vdc output models		8		%
	12 Vdc output models		7		%
	15 Vdc output models		6		%
	24 Vdc output models		5		%
voltage accuracy	see tolerance envelope curve				
switching frequency	100% load, nominal input voltage		100	300	kHz
temperature coefficient	100% load			±0.03	%/°C

## PROTECTIONS

parameter	conditions/description	min	typ	max	units
short circuit protection <sup>1</sup>	24 Vdc input dual output models all other models: automatic recovery			1	s

Note: 1. The supply voltage must be discontinued at the end of the short circuit duration

## SAFETY AND COMPLIANCE

parameter	conditions/description	min	typ	max	units
isolation voltage	input to output for 1 minute at 1 mA max.	1,500			Vdc
isolation resistance	input to output at 500 Vdc	1,000			MΩ
safety approvals <sup>2</sup>	UL 60950-1				
conducted emissions	CISPR22/EN55022, class B (external circuit required, see Figure 1)				
radiated emissions	CISPR22/EN55022, class B (external circuit required, see Figure 1)				
ESD	IEC/EN 61000-4-2, class B, contact ±8kV (single output models) IEC/EN 61000-4-2, class B, contact ±6kV (dual output models)				
MTBF	MIL-HDBK-217F @ 25 °C	3,500,000			hours
RoHS	2011/65/EU				

Note: 2. See specific models noted on pages 1 & 2

## ENVIRONMENTAL

parameter	conditions/description	min	typ	max	units
operating temperature	see derating curve	-40		105	°C
storage temperature		-55		125	°C
storage humidity	non-condensing			95	%
temperature rise	at full load, Ta=25°C		25		°C

## SOLDERABILITY

parameter	conditions/description	min	typ	max	units
hand soldering	1.5 mm from case for 10 seconds			300	°C
reflow soldering	see reflow soldering profile			245	°C

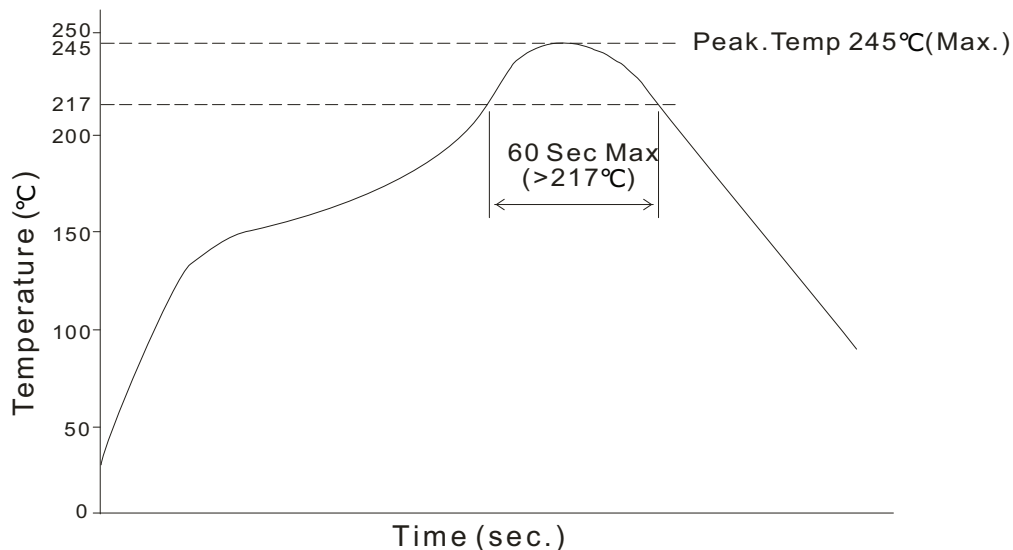

## MECHANICAL

parameter	conditions/description	min	typ	max	units
dimensions	single output models: 12.7 x 8.30 x 7.25 dual output models: 15.24 x 8.30 x 7.25				mm mm
case material	epoxy resin (UL94-V0)				
weight	single output models dual output models		1.5 1.8		g g

## MECHANICAL DRAWING

### SINGLE OUTPUT MODELS

units: mm[inch]  
tolerance:  $\pm 0.25[\pm 0.010]$   
pin section tolerance:  $\pm 0.10[\pm 0.004]$

PIN CONNECTIONS	
PIN	Function
1	GND
2	Vin
4	0V
5	+Vo
8	NC

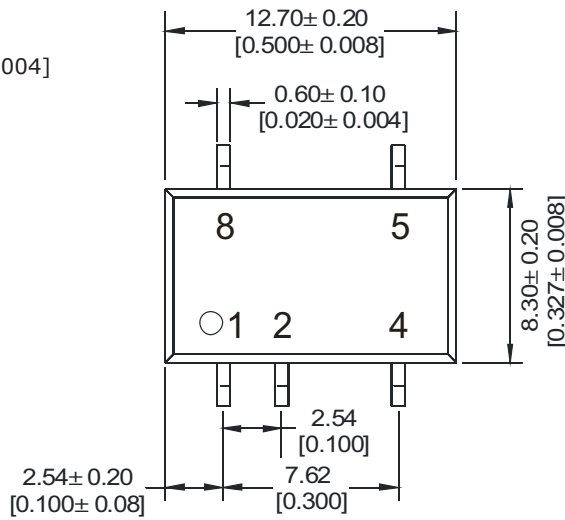

Top View

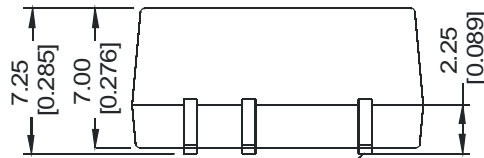

Front View

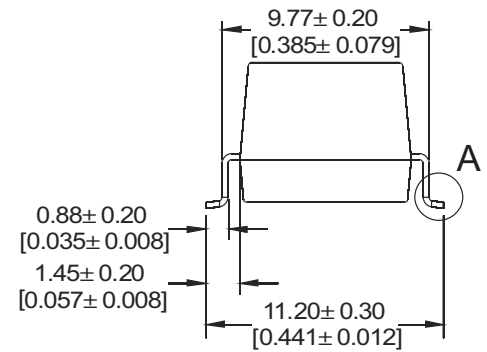

Side View

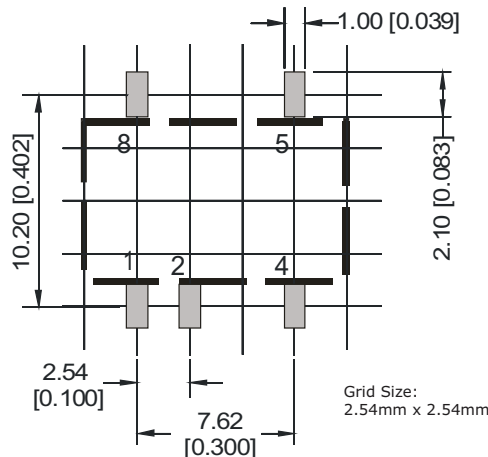

PCB Layout  
Top View

## MECHANICAL DRAWING (CONTINUED)

### DUAL OUTPUT MODELS

units: mm[inch]  
 tolerance:  $\pm 0.25[\pm 0.010]$   
 pin section tolerance:  $\pm 0.10[\pm 0.004]$

PIN CONNECTIONS	
PIN	Function
1	GND
2	Vin
4	0V
5	-Vo
7	+Vo
10	NC

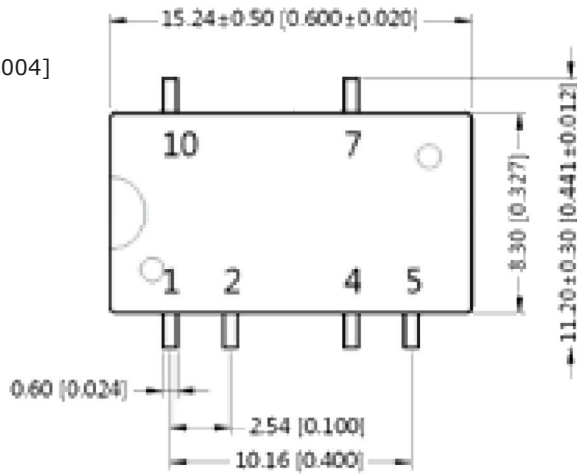

Top View

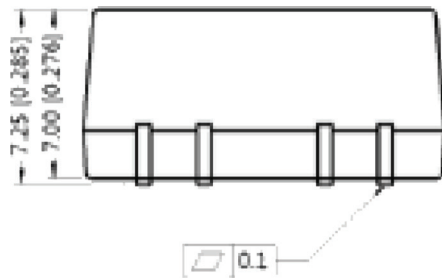

Front View

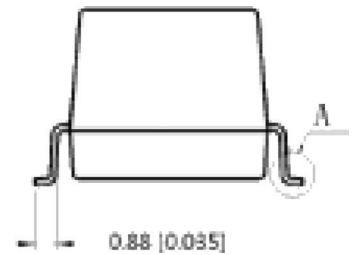

Side View

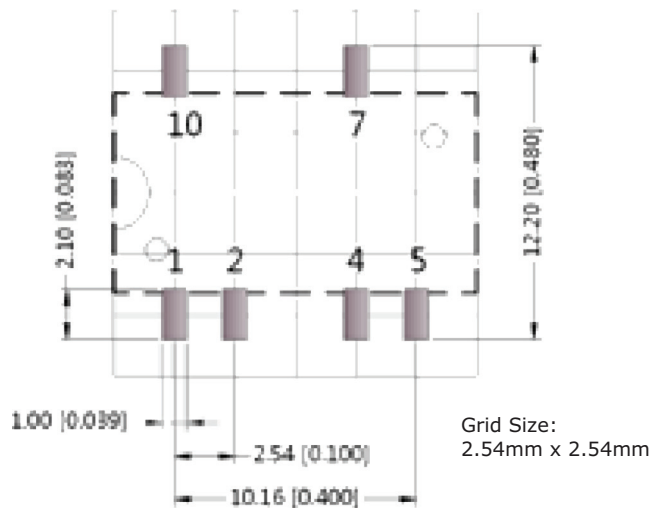

PCB Layout  
Top View

## DERATING CURVES

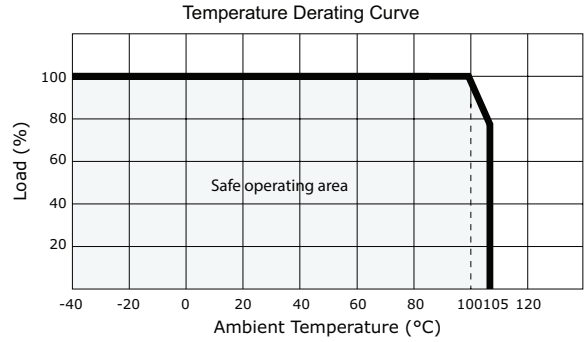
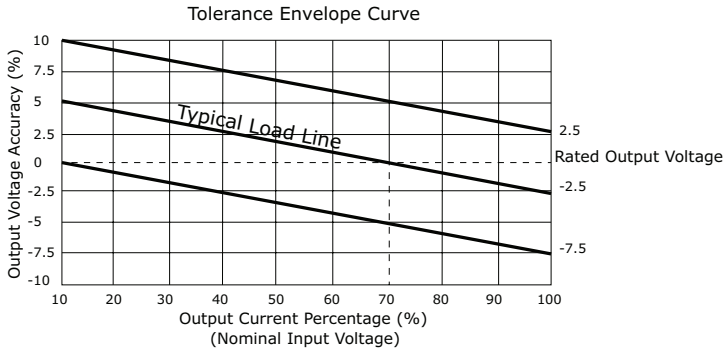

## EMC RECOMMENDED CIRCUIT

**Figure 1**

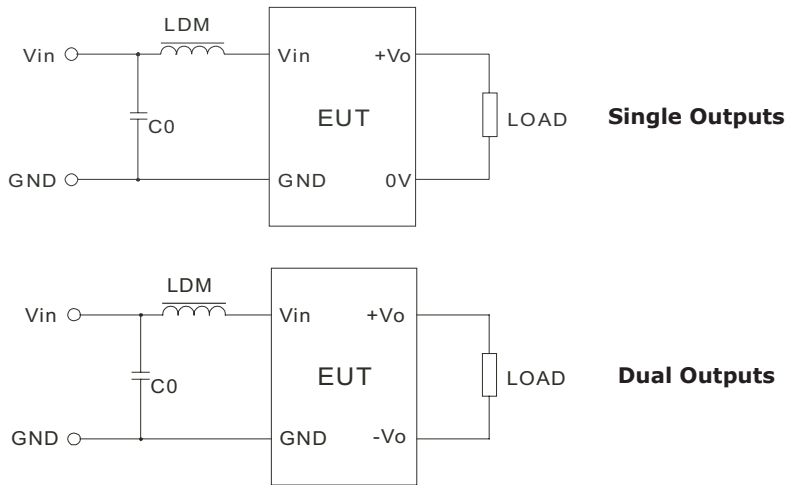
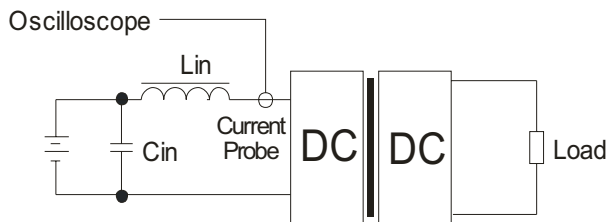

**Table 1**

Recommended external circuit components		
$V_{in}$ (Vdc)	$C_0$	LDM
3.3	4.7 $\mu$ F/50V	6.8 $\mu$ H
5	4.7 $\mu$ F/50V	6.8 $\mu$ H
12	4.7 $\mu$ F/50V	6.8 $\mu$ H
15	4.7 $\mu$ F/50V	6.8 $\mu$ H
24	4.7 $\mu$ F/50V	6.8 $\mu$ H

## TEST CONFIGURATION

**Figure 2**



**Table 2**

External components	
$L_{in}$	4.7 $\mu$ H
$C_{in}$	220 $\mu$ F, ESR < 1.0 $\Omega$ at 100 kHz

Note: Input reflected-ripple current is measured with an inductor  $L_{in}$  and Capacitor  $C_{in}$  to simulate source impedance.

## APPLICATION NOTES

### 1. Output load requirement

To ensure this module can operate efficiently and reliably, the minimum output load may not be less than 10% of the full load during operation. If the actual output power is low, connect a resistor at the output end in parallel to increase the load.

### 2. Overload Protection

Under normal operating conditions, the output circuit of this product has no protection against overload. The simplest method to add this is to add a circuit breaker to the circuit.

### 3. Recommended circuit

If you want to further decrease the input/output ripple, you can increase the capacitance accordingly or choose capacitors with low ESR (see Figure 3 & Table 3). However, the capacitance of the output filter capacitor must be appropriate. If the capacitance is too high, a startup problem might arise. For every channel of the output, to ensure safe and reliable operation, the maximum capacitance must be less than the maximum capacitive load (see Table 4).

Figure 3

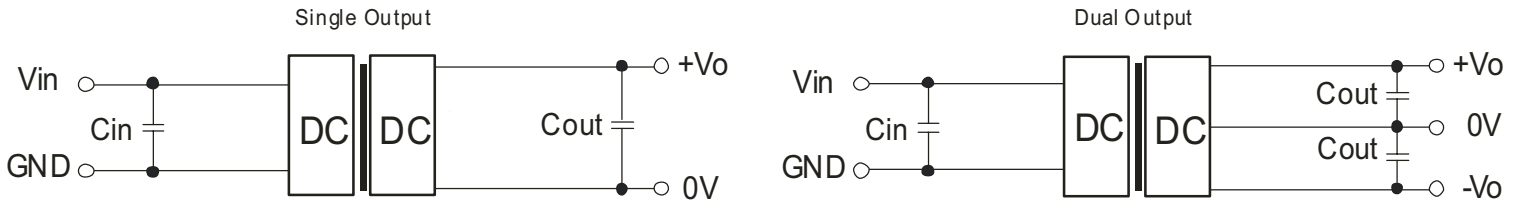

Table 3

Vin (Vdc)	Cin (μF)	Single Vo (Vdc)	Cout (μF)	Dual Vo (Vdc)	Cout (μF)
3.3	4.7	3.3	10	-	-
5	4.7	5	10	±5	4.7
12	2.2	9	4.7	±9	2.2
15	2.2	12	2.2	±12	1
24	1	15	1	±15	1
-	-	24	0.47	±24	0.47

Note: It's not recommended to connect any external capacitors in applications with less than 0.5 watt output.

Table 4

Single Vout (Vdc)	Max. Capacitive Load (μF)	Dual Vout (Vdc)	Max. Capacitive Load <sup>1</sup> (μF)
3.3	220	-	-
5	220	5	100
9	220	9	100
12	220	12	100
15	220	15	100
24	220	24	100

Note: 1. For each output.

### 4. Output Voltage Regulation and Over-voltage Protection Circuit

The device for output voltage regulation, over-voltage and over-current protection is a linear regulator and a capacitor filtering network with overheat protection which can be connected to the input or output end in series (see Figure 4). The recommended capacitance of its filter capacitor (see Table 3), and the linear regulator is based on the actual voltage and current required.

Figure 4

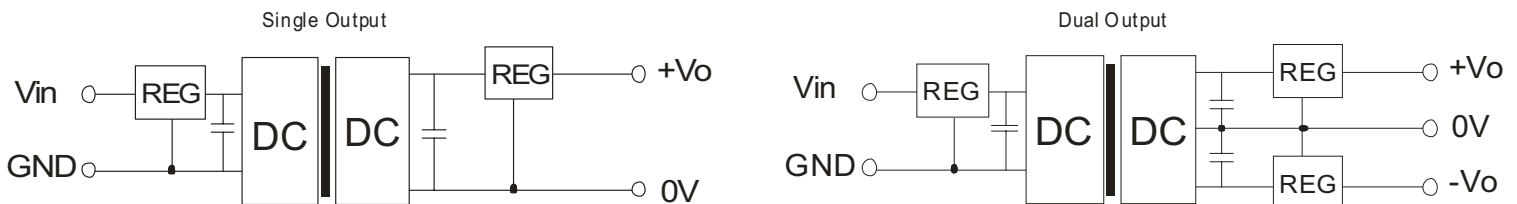

Note: 1. Operation under minimum load will not damage the converter; however, they may not meet all specifications listed.

2. Max. capacitive load tested at input voltage range and full load.

3. It is recommended to use either ceramic capacitors or electrolytic capacitors on the input and the output. Using tantalum capacitors may increase the risk of failure.

4. All specifications measured at: Ta=25°C, humidity<75%, nominal input voltage and rated output load, unless otherwise specified.

## REVISION HISTORY

---

rev.	description	date
1.0	initial release	03/19/2013
1.01	added PDS1-S24-S12-M model	06/11/2013
1.02	added dual output models	02/17/2014
1.03	added models PDS1-S3-S3-M, PDS1-S3-S5-M, PDS1-S5-S3-M, and PDS1-S12-S3-M	04/18/2014
1.04	added UL approval to some models, updated spec	10/03/2014

The revision history provided is for informational purposes only and is believed to be accurate.

**CUI INC<sup>®</sup>**

**Headquarters**  
20050 SW 112th Ave.  
Tualatin, OR 97062  
**800.275.4899**

Fax 503.612.2383  
**cui.com**  
techsupport@cui.com

CUI offers a two (2) year limited warranty. Complete warranty information is listed on our website.

CUI reserves the right to make changes to the product at any time without notice. Information provided by CUI is believed to be accurate and reliable. However, no responsibility is assumed by CUI for its use, nor for any infringements of patents or other rights of third parties which may result from its use.

CUI products are not authorized or warranted for use as critical components in equipment that requires an extremely high level of reliability. A critical component is any component of a life support device or system whose failure to perform can be reasonably expected to cause the failure of the life support device or system, or to affect its safety or effectiveness.