

VT Series

30W 2:1 Regulated Single & Dual output

Features

- Ultra Wide 2:1 Input Range
- Full SMD Technology
- 1600 VDC Isolation
- Efficiency up to 92%
- Extended Operating Temperature Range -40 ~ 75°C max.
- Adjustable Output Voltage
- Remote On/Off Control (CTRL)
- Continuous Short Circuit Protection
- Over Current Protection
- Over Voltage Protection
- Over Temperature Protection
- Soft Start



The VT series is a family of cost effective 30W single & dual & output DC-DC converters. These converters combine nickle-coated copper package in a 2"x1" case with high performance features such as Active Clamp Technology, continuous short circuit protection with automatic restart and tight line / load regulation. Devices are encapsulated using flame retardant resin. Input voltages of 12 and 24 and 48 with output voltage of 3.3 , 5 , 5.1, 12, 15, ± 5 , ± 12 , ± 15 Vdc . High performance features include high efficiency operation up to 92% .

ALL SPECIFICATIONS ARE TYPICAL AT 25°C, NOMINAL INPUT AND FULL LOAD UNLESS OTHERWISE NOTED.

OUTPUT SPECIFICATIONS	
Output Voltage Accuracy	Single&Dual: $\pm 1\%$
Output Voltage Adjustability (Single Output Only)	$\pm 10\%$, max.
Maximum Output Current	See table
Line Regulation	Single&Dual: $\pm 0.5\%$, max.
Load Regulation	Single (0% to 100%): $\pm 0.5\%$, max. Dual (0% to 100%): $\pm 1\%$, max(balanced load)
Cross Regulation (1)	Dual: $\pm 5\%$
Ripple&Noise (2)	Single&Dual : 100mVp-p,max.
Over Voltage Protection (Zener diode clamp)	3.3V output 3.9V 5V output 6.2V 5.1V output 6.2V 12V output 15V 15V output 18V ± 5 V output ± 6.2 V ± 12 V output ± 15 V ± 15 V output ± 18 V
Over Load Protection	150% of FL, typ.
Short Circuit Protection	Indefinite(hiccup) (Automatic Recovery)
Temperature Coefficient	$\pm 0.02\%/^{\circ}\text{C}$
Capacitive Load (3)	See table
Transient Recovery Time (4)	250us, typ.
Transient Response Deviation (4)	$\pm 3\%$, max.

INPUT SPECIFICATIONS	
Input Voltage Range	See table
Under Voltage Lockout	
12V Models	Module ON / OFF 8.6Vdc / 7.9Vdc, typ.
24V Models	Module ON / OFF 17.8Vdc / 16Vdc, typ.
48V Models	Module ON / OFF 33.5Vdc / 30.5Vdc, typ.
Start up Time (Nominal Vin and constant resistive load)	30mS, typ.
Input Filter	Pi Type
Input Current (No-Load)	See table, max.
Input Current (Full-Load)	See table, typ.
Input Reflected Ripple Current (5)	20mA _{p-p} , typ.
Remote On/Off (CTRL) (6)	
ON:	3.0 ... 12Vdc or open circuit
OFF:	0 ... 1.2Vdc or Short circuit pin2 and pin 3
OFF idle current:	5 mA, typ.

GENERAL SPECIFICATIONS	
Efficiency	See table, typ.
I/O Isolation Voltage (3 sec)	
Input/Output	1600Vdc
Case/Input & Output	1600Vdc
Isolation Resistance	1000 M Ω , min.
Isolation Capacitance	1000 pF, typ.
Switching frequency	330kHz, typ.
Humidity	95% rel H
Reliability Calculated MTBF (MIL-HDBK-217 F)	Single&Dual: >435 khrs
Safety Standard (designed to meet)	IEC/EN 60950-1

EMC CHARACTERISTICS		
Radiated Emissions	EN55022	CLASSA
Conducted Emissions(7)	EN55022	CLASSA
ESD	EN61000-4-2	Perf. Criteria A
RS	EN61000-4-3	Perf. Criteria A
EFT(8)	EN61000-4-4	Perf. Criteria A
Surge (8)	EN61000-4-5	Perf. Criteria A
CS	EN61000-4-6	Perf. Criteria A
PFMF	EN61000-4-8	Perf. Criteria A

PHYSICAL SPECIFICATIONS	
Case Material	Nickel-coated Copper
Base Material	Non-conductive Black Plastic(UL94V-0 rated)
Pin Material	1.0mm Brass Solder-coated
Potting Material	Epoxy (UL94V-0 rated)
Weight	31.0g
Dimensions	

ABSOLUTE SPECIFICATIONS (9)	
These are stress ratings. Exposure of devices to any of these conditions may adversely affect long-term reliability.	
Input Surge Voltage (100mS)	
12 Models	25 Vdc max.
24 Models	50 Vdc max.
48 Models	100 Vdc max.
Soldering Temperature (1.5mm from case 10 sec. max.)	260°C max.

ENVIRONMENTAL SPECIFICATIONS	
Operating Ambient Temperature	-40°C ~ +75°C(See Derating Curve) -40°C ~ +50°C(For 100% load)
Maximum Case Temperature	105°C
Storage Temperature	-55°C ~ +125°C
Over Temperature Protection (Case)	115°C, typ.
Cooling(10)	Nature Convection

VT - 30W 2:1 Regulated Single & Dual output

PART NUMBER STRUCTURE

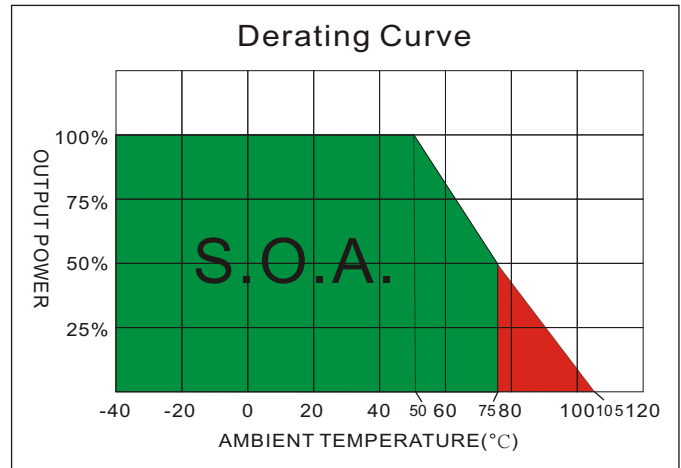
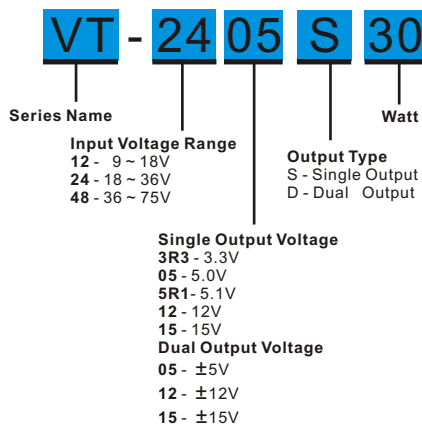

MODEL SELECTION GUIDE

MODEL NUMBER	INPUT Voltage Range (Vdc)	INPUT Current		OUTPUT Voltage (Vdc)	OUTPUT Current		EFFICIENCY @FL(%)	Capacitor Load(uF)
		No-Load (mA)	Full Load (mA)		Min-Load (mA)	Full Load (mA)		
VT-123R3S30	9-18	80	2426	3.3	0	8000	89	20000
VT-1205S30	9-18	180	2874	5	0	6000	91	14000
VT-125R1S30	9-18	160	2874	5.1	0	6000	92	14000
VT-1212S30	9-18	30	2809	12	0	2500	91	2000
VT-1215S30	9-18	30	2809	15	0	2000	92	2000
VT-243R3S30	18-36	70	1185	3.3	0	8000	91	20000
VT-2405S30	18-36	100	1420	5	0	6000	92	14000
VT-245R1S30	18-36	100	1448	5.1	0	6000	92	14000
VT-2412S30	18-36	20	1436	12	0	2500	92	2000
VT-2415S30	18-36	40	1420	15	0	2000	92	2000
VT-483R3S30	36-75	50	593	3.3	0	8000	90	20000
VT-4805S30	36-75	70	702	5	0	6000	91	14000
VT-485R1S30	36-75	70	724	5.1	0	6000	91	14000
VT-4812S30	36-75	30	718	12	0	2500	91	2000
VT-4815S30	36-75	30	710	15	0	2000	91	2000
VT-1205D30	9-18	180	2874	± 5	0	± 3000	89	± 3000
VT-1212D30	9-18	50	2874	± 12	0	± 1250	90	± 1300
VT-1215D30	9-18	50	2874	± 15	0	± 1000	91	± 1300
VT-2405D30	18-36	100	1437	± 5	0	± 3000	90	± 3000
VT-2412D30	18-36	40	1453	± 12	0	± 1250	91	± 1300
VT-2415D30	18-36	50	1437	± 15	0	± 1000	91	± 1300
VT-4805D30	36-75	70	710	± 5	0	± 3000	90	± 3000
VT-4812D30	36-75	50	718	± 12	0	± 1250	90	± 1300
VT-4815D30	36-75	40	718	± 15	0	± 1000	90	± 1300

NOTE

1. Dual: One load is 25% to 100% load, the other load is 100% load, the output voltage variable rate is within $\pm 5\%$.
2. Measured with 20MHz bandwidth and 1.0uF ceramic capacitor.
3. Tested by minimal Vin and constant resistive load.
4. Tested by normal Vin and 25% load step change (75%-50%-25% of Io).
5. Measured Input reflected ripple current with a simulated source inductance of 4.7uH.
6. The remote on/off control pin is referenced to -Vin(pin2).
7. The VT series can meet EN55022 Class A With an external filter in parallel with the input pins .
8. An external filter capacitor is required if the module has to meet EN61000-4-4 and EN61000-4-5. The filter capacitor Motien suggest: Nippon chemi-con KY series, 220uF/100V.
9. Exceeding the absolute ratings of the unit could cause damage. It is not allowed for continuous operating.
10. "Nature Convection" is usually about 30-65 LFM but is not equal to still air (0 LFM).

TEST CONFIGURATIONS

Input Reflected Ripple Current Test Step

Input reflected ripple current is measured through a source inductor L_{in} (4.7uH) and a source capacitor C_{in} (33uF, ESR<1.0Ω at 100KHz) at nominal input and full load.

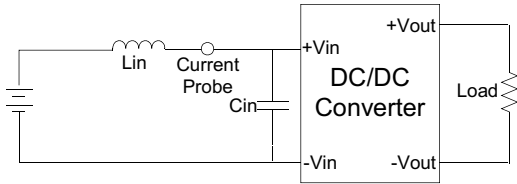

Output Ripple & Noise Measurement Test

Use a capacitor C_{out} (1.0uF) measurement. The Scope measurement bandwidth is 0-20MHz.

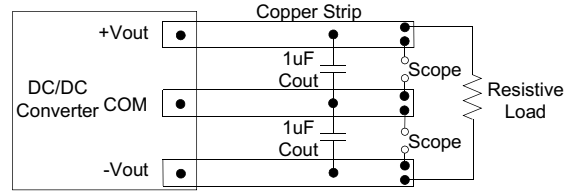

DESIGN & FEATURE CONFIGURATIONS

Output Ripple & Noise Reduction

To reduce ripple and noise, it is recommended to use a 1uF ceramic disk capacitor and a 10uF electrolytic capacitor to at the output.

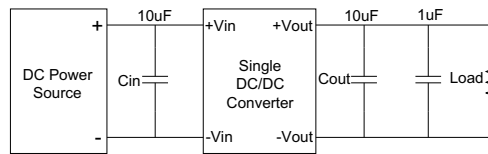

EMI Filter

Input filter components (C_1, C_3, L) are used to help meet conducted emissions requirement for the module. These components should be mounted as close as possible to the module; and all leads should be minimized to decrease radiated noise.

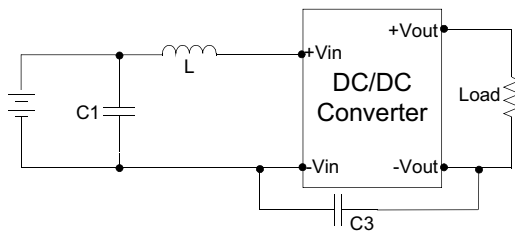

	C1	L	C3
VT-12XXXXXXXXXX	100uF, 100V	12uH	1206,470PF, 2KV
VT-24XXXXXXXXXX	100uF, 100V	12uH	1206,470PF, 2KV
VT-48XXXXXXXXXX	100uF, 100V	12uH	1206,470PF, 2KV

CTRL Module ON / OFF

Positive logic turns on the module during high logic and off during low logic. Ctrl module on/off can be controlled by an external switch between the ctrl terminal and -Vin terminal. The switch can be an open collector or open drain. For positive logic if the ctrl feature is not used, please leave the ctrl pin floating.

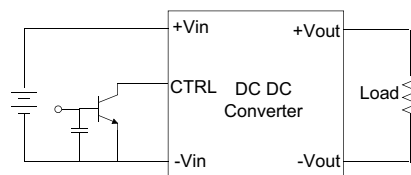

ELECTRICAL CHARACTERISTIC CURVES

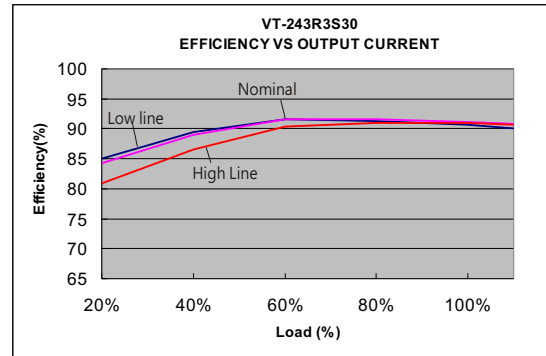
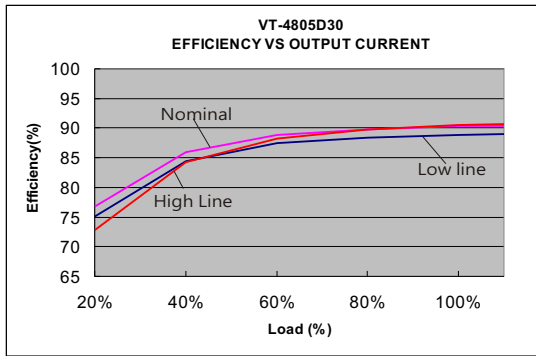
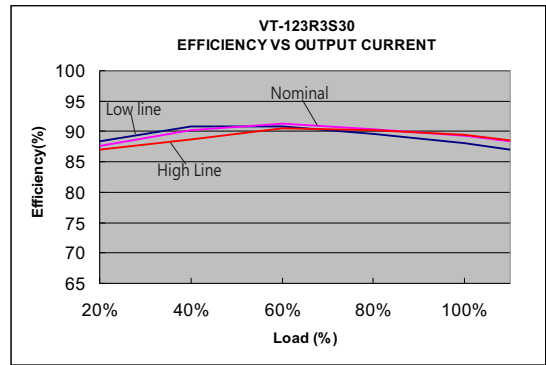
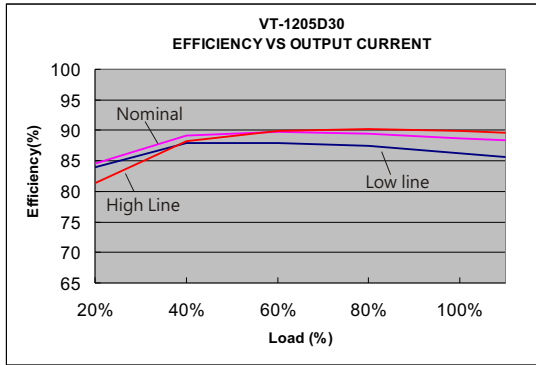

MECHANICAL SPECIFICATIONS

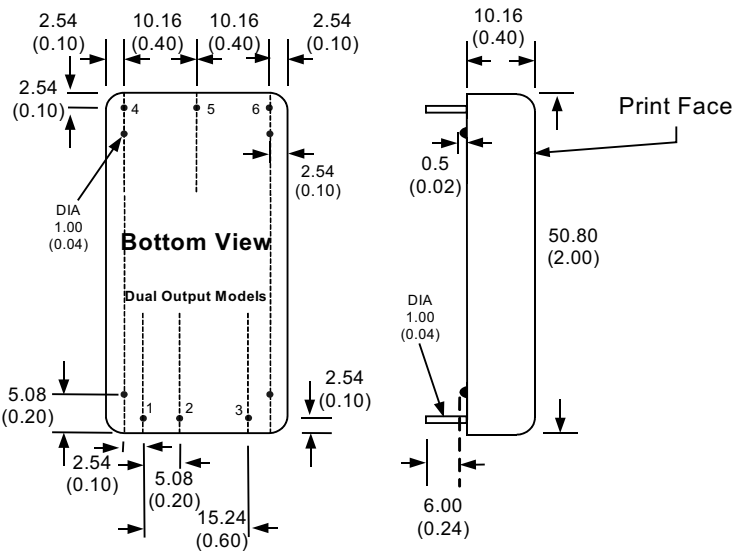

PIN CONNECTIONS		
PIN NUMBER	SINGLE	DUAL
1	+Vin	+Vin
2	-Vin	-Vin
3	CTRL	CTRL
4	+Vout	+Vout
5	-Vout	Com
6	Trim	-Vout

EXTERNAL OUTPUT TRIMMING
Output can be externally trimmed by using the method as below. (single output models only)

- All dimensions are typical in millimeters (inches).
1. Pin diameter: 1.0 ±0.05 (0.04 ±0.002)
 2. Pin pitch and length tolerance: ±0.35 (±0.014)
 3. Case Tolerance: ±0.5 (±0.02)
 4. Stand-off Tolerance: ±0.1 (±0.004)