

# V7L - 25W Series



25W 2:1 Regulated Single & Dual output

## Features

- Wide 2:1 Input Range
- Full SMD Technology
- 1500 VDC Isolation
- Continuous Short Circuit Protection
- Efficiency up to 88%
- -40 ~ 85°C Operation Temperature Range



The V7L series is a family of cost effective 25W single & dual output DC-DC converters. These converters are made with nickle-coated brass case in a 2"x2" with high performance features such as 1500 VDC input/output isolation voltage, continuous short circuit protection with automatic restart and tight line / load regulation. Devices are encapsulated by using flame retardant resin. Input voltages of 12, 24 and 48 with output voltage of 3.3, 5, 7.2, 9, 12, 15, 18, 24, ±3.3, ±5, ±7.2, ±9, ±12, ±15, ±18, ±24 Vdc. High performance features include high efficiency operation up to 88% and output voltage accuracy of ±1% maximum.

All specifications typical at Ta=25°C, nominal input voltage and full load unless otherwise specified

OUTPUT SPECIFICATIONS	
Voltage accuracy	±1%
Line regulation	±0.5%
Load regulation	Single (0% to 100% Load) ±0.5% Dual (10% to 100% Load) ±0.5%
Ripple & noise(20 MHz bandwidth)(1)	100mV pk-pk
Over-current protection	140% of max. Iout
Short circuit protection	Indefinite(Automatic Recovery)
Temperature coefficient	±0.02%/°C
Capacitor load(2)	See table

INPUT SPECIFICATIONS	
Voltage Range	See table
Start up Time(Nominal Vin and constant resistive load)	20mS, typ.
Max. Input Current	See table
No-Load Input Current	See table
Input Filter	Capacitors
Input Reflected Ripple Current(3)	35mA pk-pk

GENERAL SPECIFICATIONS	
Efficiency	See table
I/O Isolation Voltage(3 sec)	
Input/Output	1500Vdc
Case/Input & Output	1000Vdc
I/O Isolation Capacitance	1000 pF typ.
I/O Isolation Resistance	1000M Ohm
Switching Frequency	Typical 125kHz
Humidity	95% rel H
Reliability Calculated MTBF(MIL-HDBK-217 F)	>1.121 Mhrs
Safety Standard : (designed to meet)	IEC 60950-1

PHYSICAL SPECIFICATIONS	
Case Material	Nickel-coated Brass
Pin Material	Ø1.0mm Brass Solder-coated
Potting Material	Epoxy (UL94V-0-rated)
Weight	60.0g
Dimensions	2.00"x2.00"x0.40"

ENVIRONMENT SPECIFICATIONS	
Operating Temperature	-40°C~85°C(See Derating Curve)
Temperature	-40°C~65°C(For 100% load)
Maximum Case Temperature	100°C
Storage Temperature	-40°C~125°C
Cooling	Nature Convection

ABSOLUTE MAXIMUM RATINGS(4)	
These are stress ratings. Exposure of devices to any of these conditions may adversely affect long-term reliability.	
Input Surge Voltage(100mS)	
12 Models	25 Vdc max.
24 Models	50 Vdc max.
48 Models	100 Vdc max.
Soldering Temperature	260°C
(1.5mm from case 10sec.max.)	

The information and specifications contained in this data sheet are believed to be correct at time of publication. However, MOTIEN Technologies accepts no responsibility for consequences arising from printing errors or inaccuracies. Specifications are subject to change without notice. No rights under any patent accompany the sale of any such product(s) or information contained herein.

## V7L - 25W 2:1 Regulated Single & Dual output

### PARTNUMBER STRUCTURE

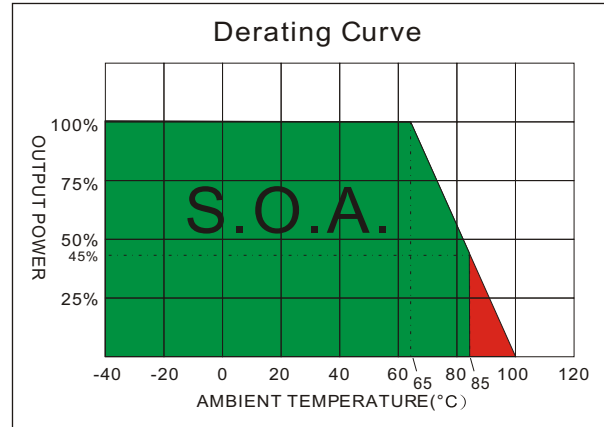
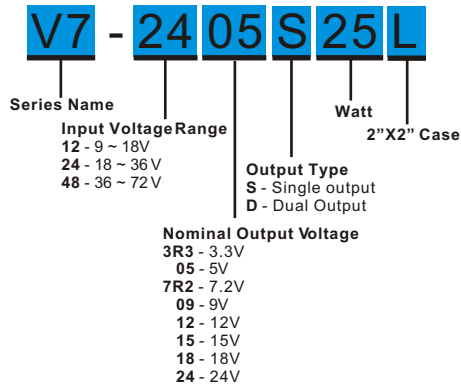

## MODEL SELECTION GUIDE

MODEL NUMBER	INPUT Voltage Range (Vdc)	INPUT Current		OUTPUT Voltage (Vdc)	OUTPUT Current		EFFICIENCY @FL (%)	Capacitor Load (uF)
		No-Load (mA)	Full Load (mA)		Min. load (mA)	Full load (mA)		
V7-1205 S25L	9-18	20	2510	5	0	5000	83	3300
V7-127R2 S25L	9-18	20	2480	7.2	0	3472	84	2200
V7-1209 S25L	9-18	20	2480	9	0	2777	84	1000
V7-1212 S25L	9-18	20	2480	12	0	2083	84	1000
V7-1215 S25L	9-18	30	2450	15	0	1666	85	680
V7-1218 S25L	9-18	30	2450	18	0	1388	85	470
V7-1224 S25L	9-18	30	2450	24	0	1041	85	470
V7-123R3D 25L	9-18	20	1718	±3.3	±0	±2500	80	±1500
V7-1205D2 5L	9-18	25	2540	±5	±0	±2500	82	±1500
V7-127R2D 25L	9-18	25	2510	±7.2	±0	±1736	83	±1000
V7-1209D2 5L	9-18	25	2480	±9	±0	±1388	84	±680
V7-1212D2 5L	9-18	30	2480	±12	±0	±1041	84	±470
V7-1215D2 5L	9-18	30	2450	±15	±0	±833	85	±330
V7-1218D2 5L	9-18	35	2450	±18	±0	±694	85	±220
V7-1224D2 5L	9-18	35	2450	±24	±0	±520	85	±220
V7-243R3 S25L	18-36	25	838	3.3	0	5000	82	3300
V7-2405 S25L	18-36	25	1240	5	0	5000	84	3300
V7-247R2 S25L	18-36	25	1240	7.2	0	3472	84	2200
V7-2409 S25L	18-36	25	1240	9	0	2777	84	1000
V7-2412 S25L	18-36	25	1225	12	0	2083	85	1000
V7-2415 S25L	18-36	25	1225	15	0	1666	85	680
V7-2418 S25L	18-36	25	1225	18	0	1388	85	470
V7-2424 S25L	18-36	25	1211	24	0	1041	86	470
V7-243R3D 25L	18-36	25	859	±3.3	±0	±2500	80	±1500
V7-2405D2 5L	18-36	25	1240	±5	±0	±2500	84	±1500
V7-247R2D 25L	18-36	25	1240	±7.2	±0	±1736	84	±1000
V7-2409D2 5L	18-36	25	1240	±9	±0	±1388	84	±680
V7-2412D2 5L	18-36	25	1225	±12	±0	±1041	85	±470
V7-2415D2 5L	18-36	25	1211	±15	±0	±833	86	±330
V7-2418D2 5L	18-36	25	1211	±18	±0	±694	86	±220
V7-2424D2 5L	18-36	30	1197	±24	±0	±520	87	±220

The models listed above is just for standard type. If you need the special specification product, please contact our service member by telephone presented in shortform cover or e-mail to : sales@motien.com.tw

## V7L - 25W 2:1 Regulated Single & Dual output

MODEL NUMBER	INPUT Voltage Range (Vdc)	INPUT Current		OUTPUT Voltage (Vdc)	OUTPUT Current		EFFICIENCY @FL (%)	Capacitor Load (uF)
		No-Load (mA)	Full Load (mA)		Min. load (mA)	Full load (mA)		
V7-483R3 S25L	36-72	20	429	3.3	0	5000	80	3300
V7-4805 S25L	36-72	20	627	5	0	5000	83	3300
V7-487R2 S25L	36-72	20	620	7.2	0	3472	84	2200
V7-4809 S25L	36-72	20	620	9	0	2777	84	1000
V7-4812 S25L	36-72	20	612	12	0	2083	85	1000
V7-4815 S25L	36-72	20	605	15	0	1666	86	680
V7-4818 S25L	36-72	20	605	18	0	1388	86	470
V7-4824 S25L	36-72	25	592	24	0	1041	88	470
V7-483R3D 25L	36-72	20	429	±3.3	±0	±2500	80	±1500
V7-4805D2 5L	36-72	20	620	±5	±0	±2500	84	±1500
V7-487R2D 25L	36-72	20	620	±7.2	±0	±1736	84	±1000
V7-4809D2 5L	36-72	20	620	±9	±0	±1388	84	±680
V7-4812D2 5L	36-72	20	612	±12	±0	±1041	85	±470
V7-4815D2 5L	36-72	20	598	±15	±0	±833	87	±330
V7-4818D2 5L	36-72	20	598	±18	±0	±694	87	±220
V7-4824D2 5L	36-72	25	598	±24	±0	±520	87	±220

### NOTE

1. Ripple/Noise measured with 20MHz bandwidth and 1.0uF ceramic capacitor.
2. Tested by minimal  $V_{in}$  and constant resistive load.
3. Measured Input reflected ripple current with a simulated source inductance of 12uH.
4. Exceeding the absolute ratings of the unit could cause damage. It is not allowed for continuous operating.
5. Operation under no-load conditions will not damage these devices, however they may not meet all listed specifications.

### TEST CONFIGURATIONS

#### Input Reflected Ripple Current Test Step

Input reflected ripple current is measured through a source inductor  $L_{in}$  (12uH) and a source capacitor  $C_{in}$  (47uF, ESR<1.0Ω at 100KHz) at nominal input and full load.

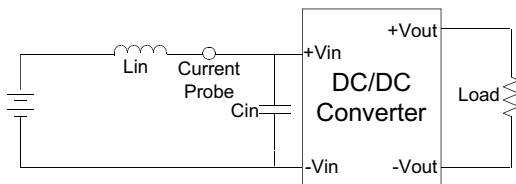

#### Output Ripple & Noise Measurement Test

To reduce ripple and noise, it is recommended to use a 1uF ceramic disk capacitor and a 10uF electrolytic capacitor to at the output.

##### Single Output

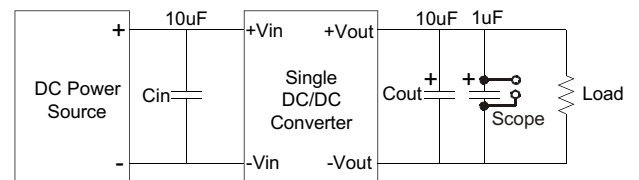

##### Dual Output

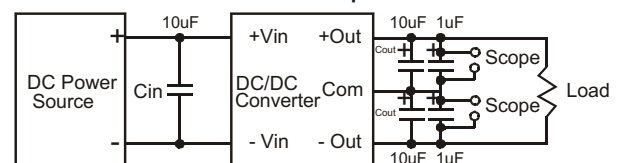

**ELECTRICAL CHARACTERISTIC CURVES**

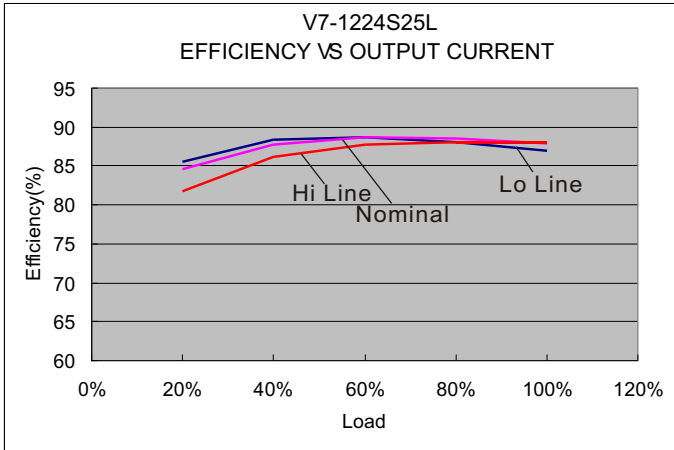

12 Models

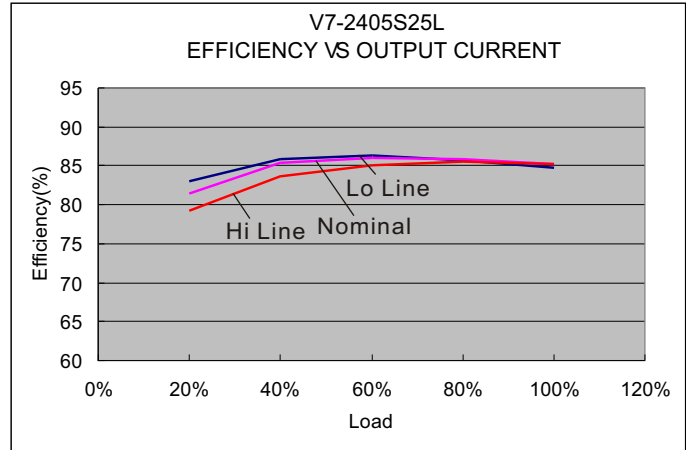

24 Models

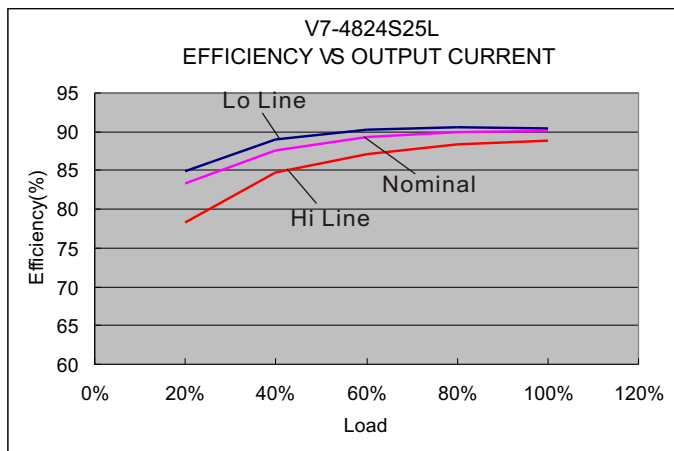

48 Models

**MECHANICAL SPECIFICATIONS**

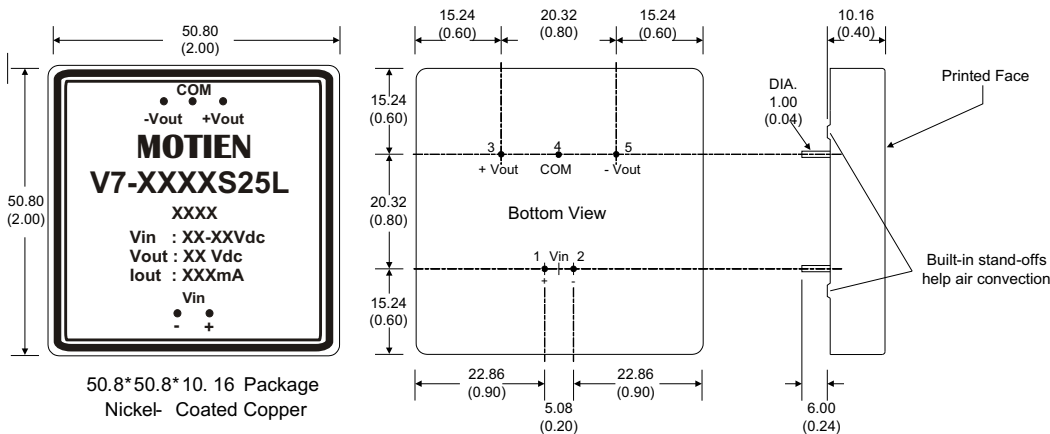

PIN CONNECTIONS		
PIN NUMBER	SINGLE	DUAL
1	+V Input	+V Input
2	-V Input	-V Input
3	+V Output	+V Output
4	N.P.	Common
5	-V Output	-V Output

- All dimensions are typical in millimeters ( inches ).
1. Pin diameter: 1.0 ±0.05 ( 0.04 ±0.002 )
  2. Pin pitch and length tolerance: ±0.35 ( ±0.014 )
  3. Case Tolerance: ±0.5 ( ±0.02 )