

# MDL24 Series

## High Efficiency Step Down LED Driver



### Features

- RoHS-compliant 16 Pin DIL Package
- Constant Current Output ( ±7% Output Current Accuracy )
- LED Driver Current 500 / 600 / 700 / 1000 mA
- Power LED Driver
- Wide Input Voltage Range: 7V to 30V ( 40V for 0.5sec. )
- Output Power 14 / 17 / 20 / 24 W
- Driver LED Strings of up to 28V ( 2V to 28V )
- High Efficiency ( up to 95% )
- PWM/Digital Dimming and Analog Voltage Dimming
- Open and Short LED Protection
- -40°C ~ 85°C Operation Temperature Range
- With MLCC Capacitors only

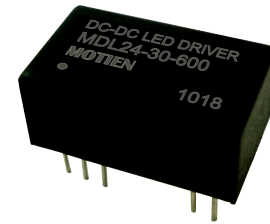

### Application

- 12V and 24V Lighting Systems
- Household/Commercial lighting
- Suitable for high illumination LED
- Power limited ( battery) lighting system

**M**DL24 Series is a high efficiency step-down converter optimized to drive high current LEDs. The control algorithm allows highly efficient and accurate LED current regulation. The device operates from an input 7Vdc to 30Vdc and provides an externally adjustable output current of up to 1000mA and output power up to 24 watts. Compact size of DIL16 allows designer to integrate this driver together with LED module. UL94V-0 grade molded case with high grade filling material provide excellent fire proof characteristics.

(Typical at Ta = +25°C, nominal input voltage, rated output current unless otherwise specified.)

Electrical Specifications:	
Input Voltage (Vdc)	7V ~ 30V, 24Vdc Nominal
Input Filter	Capacitor
Output Voltage Range (Vin = 30V)	2V to 28V
Output Current Range (Vin - Vout > 3V)	See table
Output Current Accuracy	See table
Output Power	See table
Ripple and Noise, (20 MHz bandwidth)	See table
Maximum Efficiency at Full Load	95%
Capacitive Load	47uF
Operating Frequency	50 kHz ~ 330 kHz
Short Circuit Protection	Regulated at Rated Output Current
Temperature Coefficient	±0.08%/°C, max.
Thermal Impedance (Nature Convection)	+50°C/W
Safety Standard : (designed to meet)	IEC / EN 60950-1

Environmental Specifications	
Operating Temperature Range	-40°C to +85°C (See Derating Curve)
Storage Temperature Range	-40°C to +125°C
Humidity	95% rel H
Maximum Case Temperature	+100°C
Cooling	Nature Convection
Reliability Calculated MTBF (MIL-HDBK-217 F)	>1.6 Mhrs
Soldering Temperature (1.5mm from case 10 sec. Max.)	+260°C, max.

Physical Specifications	
Case Material	Non-Conductive Black Plastic (UL94V-0 rated)
Potting Material	Silicon (UL94V-0 rated)
Pin Material	Ø0.5mm Brass Solder-coated
Weight	6.2g
Dimensions	0.92"x0.55"x0.40"

Dimming Control and ON/OFF Control (Leave Open if Not Used):	
V <sub>ADJ</sub> Pin Input Voltage Range	0V to 1.25V
V <sub>ADJ</sub> Pin Drive Current (V <sub>ADJ</sub> = 1.25V)	<1mA
Analog Dimming	
Adjust Output Current (Vin - Vout < 20V)	25% to 100%
Control Voltage Range Limits	
On	0.3V < V <sub>ADJ</sub> < 1.25V
Off	V <sub>ADJ</sub> < 0.15V
PWM Dimming	
Recommended Maximum Operation Frequency	1KHz
Adjust Output Current	0% to 100%
Remote ON/OFF	
DC/DC ON	0.3V < V <sub>ADJ</sub> < 1.25V or open circuit
DC/DC OFF (Shutdown)	V <sub>ADJ</sub> < 0.15V or Short circuit pin 1,2 and pin 3
Quiescent Input Current in Shutdown Mode (Vin = 30V)	25uA, max.

EMC SPECIFICATIONS	
EMI Radiated & Conducted Emissions	EN 55015 (CISPR22)
EMS Immunity EN61547	
IEC 61000-4-2	Perf. Criteria A
IEC 61000-4-3	Perf. Criteria A
IEC 61000-4-4	Perf. Criteria A
IEC 61000-4-6	Perf. Criteria A
IEC 61000-4-8	Perf. Criteria A

### NOTE

1. Reversed power source damages the circuit, No connection is allowed between input ground and output.
2. DO NOT operate the driver over 24W output.
3. Leave pin V<sub>ADJ</sub> open if not in use, ground pin to shut down the converter. Connecting V<sub>adj</sub> to Vin damages the circuit.
4. Maximum output open voltage is equal to input voltage.
5. Input filter components (C1, L, C2) are used to help meet conducted emissions requirement for the module.
6. For the compliance with IEC61000-4-5, a TVS is thus recommended to be installed in front of the input filter, the reference model: 3.0SMCJ24A or SMCJ24A (TVS Max Clamping Voltage @ Max Peak Pulse Current VC (V) ≤ 40V)

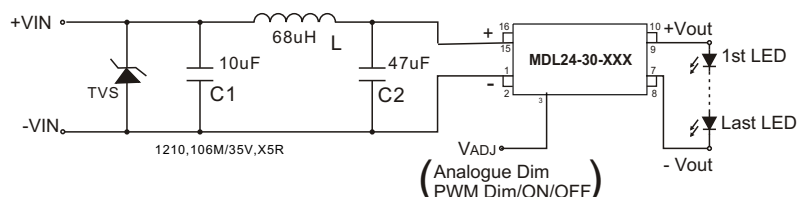

The information and specifications contained in this data sheet are believed to be correct at time of publication. However, MOTIEN Technologies accepts no responsibility for consequences arising from printing errors or inaccuracies. Specifications are subject to change without notice. No rights under any patent accompany the sale of any such product(s) or information contained herein.

**PART NUMBER STRUCTURE**



Series Name

Input Max. Voltage

Output Current  
 500 - 500mA  
 600 - 600mA  
 700 - 700mA  
 1000 - 1000mA

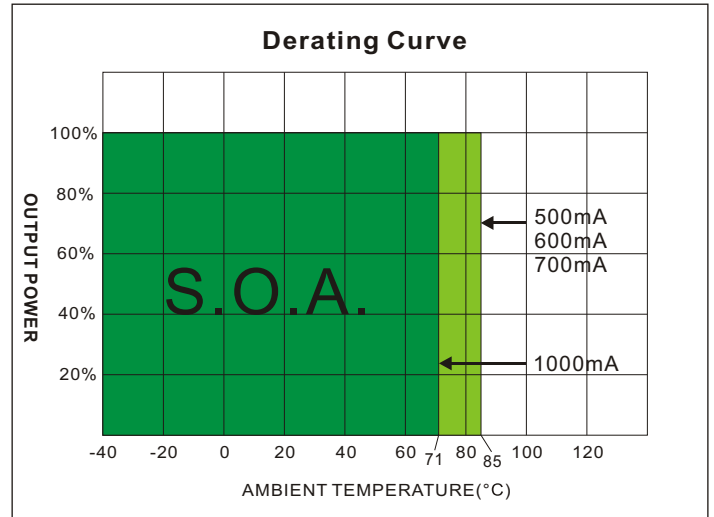

**MODEL SELECTION GUIDE**

MODEL NUMBER	INPUT	OUTPUT		OUTPUT Current	OUTPUT	EFFICIENCY @FL(%) Max.	Ripple and Noise mVp-p Max.	Capacitor Load(uF)
	Voltage Range (Vdc)	Voltage Range (Vdc)	Current (mA)	Accuracy (%)	Power (W) Max.			
MDL24-30-500	7 - 30	2 - 28	500	±6	14	75 - 95	250	47
MDL24-30-600	7 - 30	2 - 28	600	±7	17	75 - 95	250	47
MDL24-30-700	7 - 30	2 - 28	700	±7	20	75 - 95	250	47
MDL24-30-1000	7 - 30	2 - 28	1000	±7	24	75 - 95	300	47

**MECHANICAL DIMENSION**

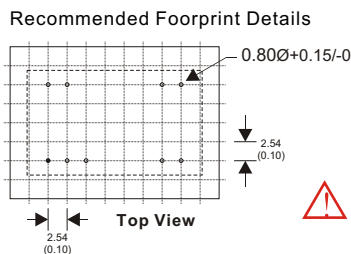
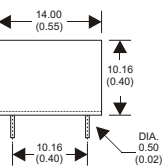
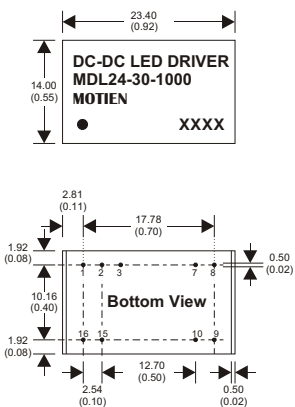

**16 Pin DIL Package**

- Notes : All dimensions are typical in millimeters ( inches ).  
 1. Pin diameter: 0.5±0.05 ( 0.02±0.002 )  
 2. Pin pitch and length tolerance: ±0.35 ( ±0.014 )  
 3. Case Tolerance: ±0.5 ( ±0.02 )

Pin #	CONNECTIONS	
1,2	- V Input	- DC Supply
3	VADJ	PWM/ON/OFF or not used
7,8	- V Output	LED Cathode Connection
9,10	+V Output	LED Anode Connection
15,16	+V Input	+DC Supply

No connection is allowed between input and output

The information and specifications contained in this data sheet are believed to be correct at time of publication. However, MOTIEN Technologies accepts no responsibility for consequences arising from printing errors or inaccuracies. Specifications are subject to change without notice. No rights under any patent accompany the sale of any such product(s) or information contained herein.

Typical electrical characteristic curves

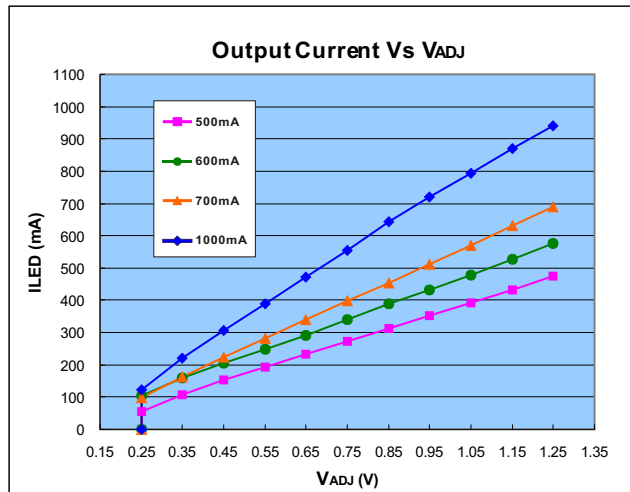

MDL24-30-500

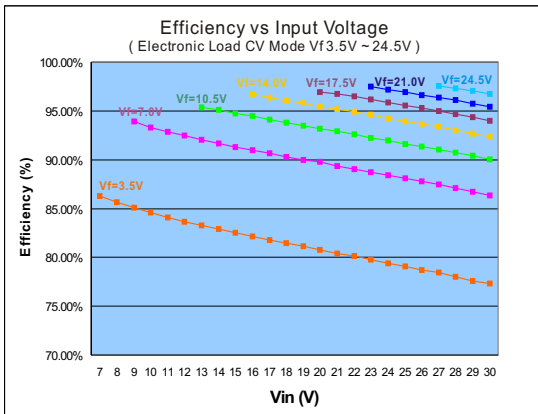

MDL24-30-600

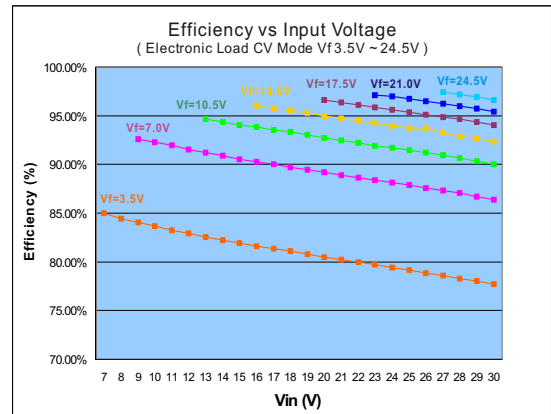

MDL24-30-700

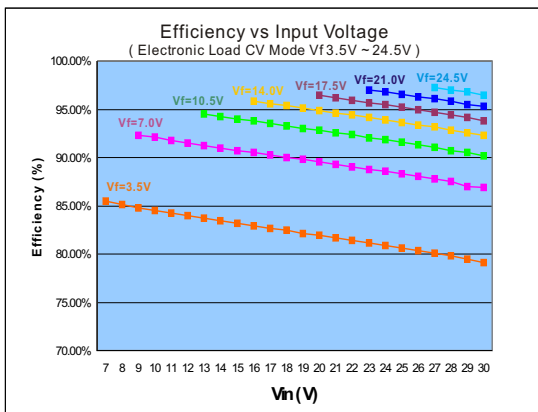

MDL24-30-1000

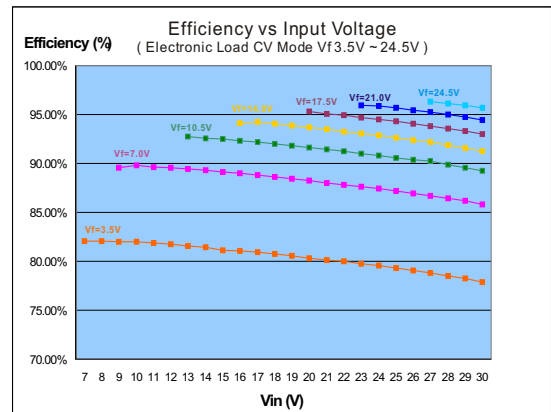

Typical Application

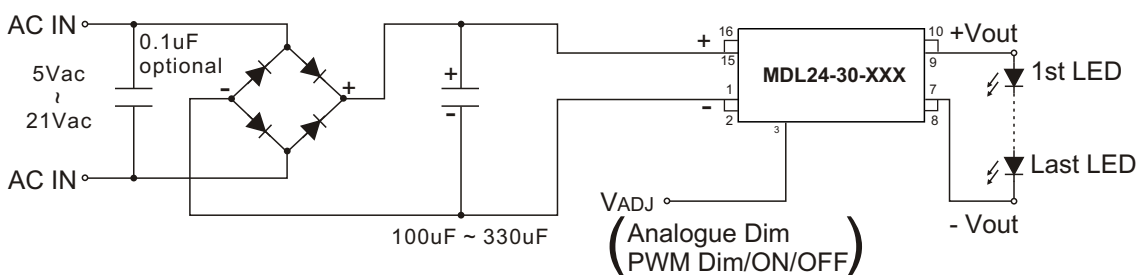
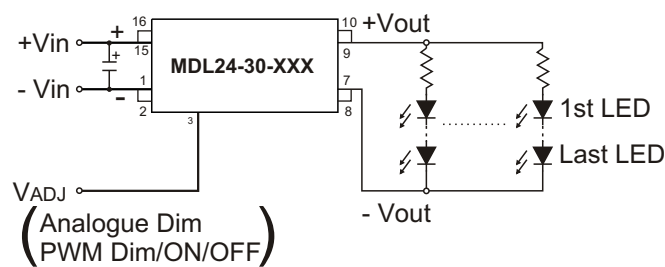
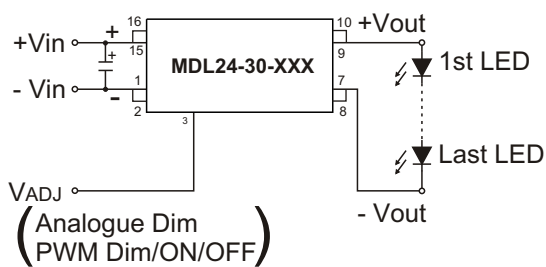

### Output Current Adjustment By External DC Control Voltage

The nominal output current is then given by:

$$I_{outnom} \approx I_{out} \times \frac{V_{ADJ}}{1.25}$$

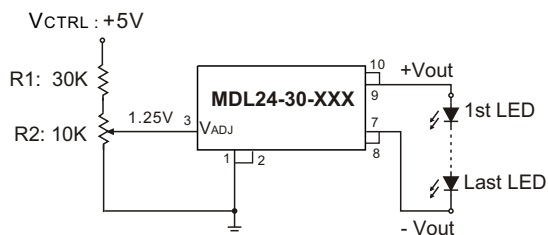
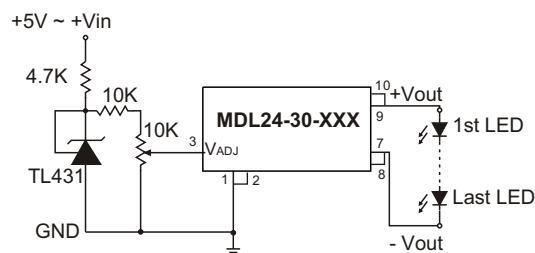
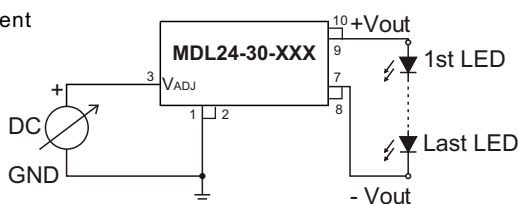

$$V_{ADJ} = \frac{R_2}{R_1 + R_2} \times V_{CTRL}$$

### Resistor dimming

By connecting a variable resistor between ADJ and GND, simple dimming can be achieved. Capacitor CADJ is optional for better AC mains interference and HF noise rejection. Recommend value of CADJ is 0.22uF.

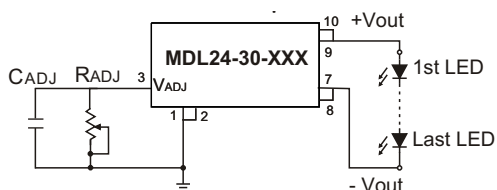

The current output  $I_{outnom}$  can be determined using the equation:

$$I_{outnom} = \frac{I_{out} \times R_{ADJ}}{(R_{ADJ} + 200K)}$$

If the value of RADJ is 0 to 2M ohm, the maximum adjust range of output current is 25% to 90%. (For  $V_{in}-V_{out} < 20V_{dc}$ )

Typical Application

## Output Current Adjustment By PWM Control

### Directly driving ADJ input

A Pulse Width Modulated (PWM) signal with duty cycle, DPWM, can be applied to the ADJ pin, as shown below

$$I_{outnom} \approx I_{out} \times DPWM \quad [\text{If PWM frequency} < 200\text{Hz, for } 0.1 < DPWM < 1]$$

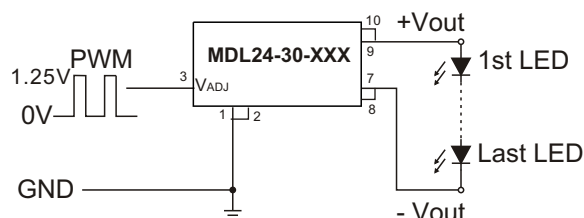

### Driving the ADJ input via open collector transistor

The diode and resistor suppress possible high amplitude negative spikes on the ADJ input resulting from the drain-source capacitance of the transistor. Negative spikes at the input to the device should be avoided as they may cause errors in output current, or erratic device operation.

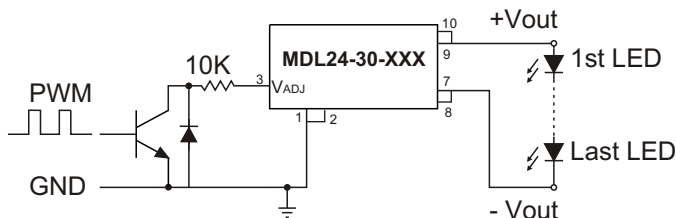

### Driving the ADJ input from a microcontroller

Another possibility is to drive the device from the open drain output of a microcontroller. The diagram below shows one method of doing this:

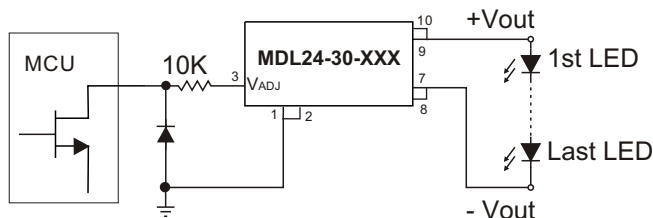

The diode and resistor suppress possible high amplitude negative spikes on the ADJ input resulting from the drain-source capacitance of the FET. Negative spikes at the input to the device should be avoided as they may cause errors in output current, or erratic device operation.

## Output Current Adjustment By PWM Control (Dimming)

To avoid visible flicker the PWM signal must be greater than 100Hz.

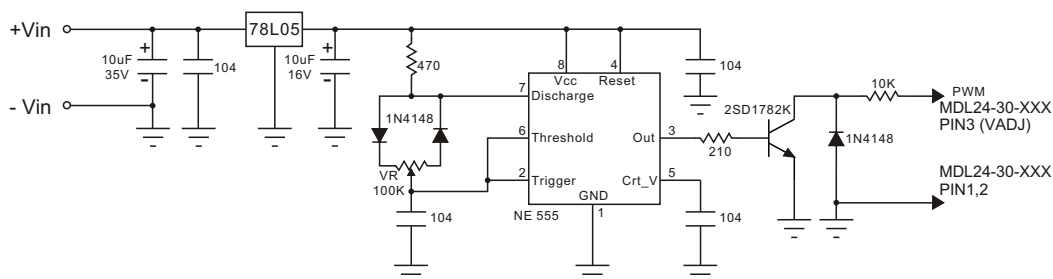

## Output Current Adjustment By PWM Control (Flash)

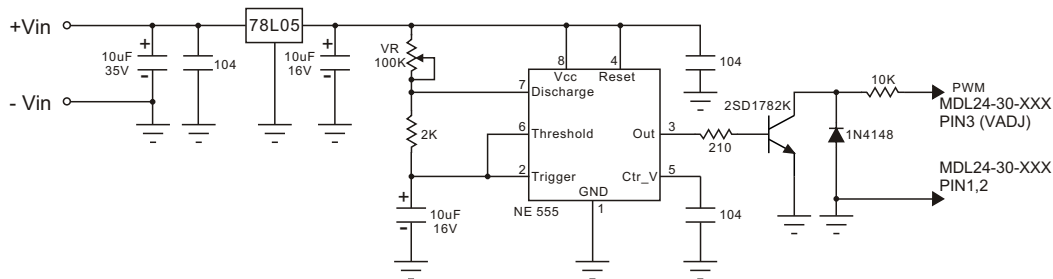

The information and specifications contained in this data sheet are believed to be correct at time of publication. However, MOTIEN Technologies accepts no responsibility for consequences arising from printing errors or inaccuracies. Specifications are subject to change without notice. No rights under any patent accompany the sale of any such product(s) or information contained herein.

Typical Application

## Output Current Adjustment By External DC Control Voltage

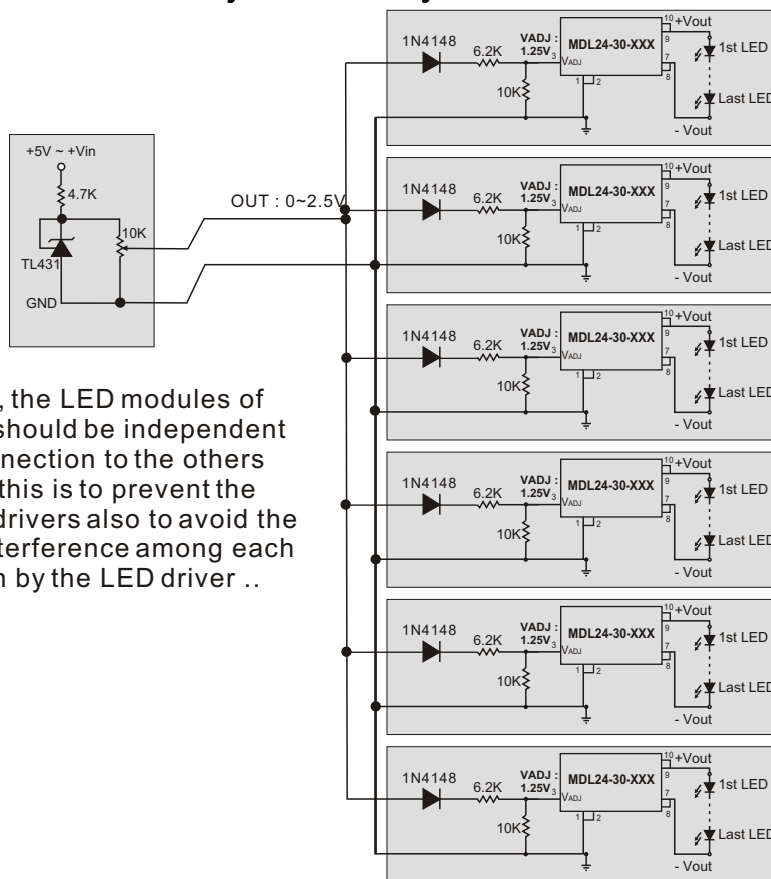

In this application , the LED modules of each LED drivers should be independent from electrical connection to the others and input power - this is to prevent the damaging to LED drivers also to avoid the un-necessaried interference among each LED module driven by the LED driver ..

## Thermal feedback circuit

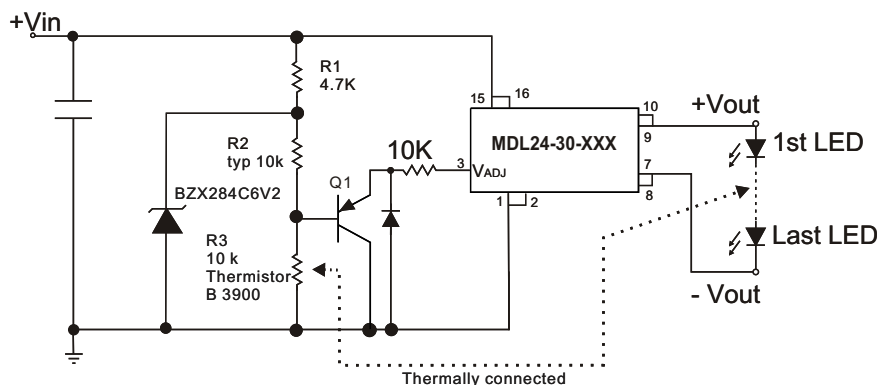

The selection of components for the thermal feedback circuit is not only dependent on the choice of R2 and R3, but also on the amount of heat sink area required to extract heat from the LEDs. To maximize the light output at high ambient or operating temperature conditions, the LEDs must have a sufficient thermal extraction path, otherwise the thermal control circuit will effect current drive reduction in non-optimal conditions. The thermal control threshold point is set by adjusting R2. For this design, three values (33k, 22k and 10k) were evaluated. These values were chosen to give break points at approximately 25°C, 40°C and 60°C. Note that the light output will not continually dim to zero - the thermal control is applying DC control to the ADJ pin and therefore has a dimming ratio from maximum Current of approximately 5:1. Once the reduced DC level goes below the shutdown threshold of around 200mV, the LED drive current will fall to zero and the LEDs will be extinguished. The slope of the current reduction is determined by the beta value of the thermistor. The larger the beta value, the sharper will be the resultant current control response. The slope of the current reduction is also affected by Q1's base emitter voltage (VBE) variation with temperature.