

V8 Series

20W 2:1 Regulated Single & Dual output



Features

- Wide 2:1 Input Range
- Full SMD Technology
- 1600 VDC Isolation
- No Minimum Load Required
- Efficiency up to 93%
- Extended Operating Temperature Range -40 ~ 85°C max.
- Adjustable Output Voltage
- Remote On/Off Control (CTRL)
- Continuous Short Circuit Protection
- Over Current Protection
- Over Voltage Protection
- Soft Start

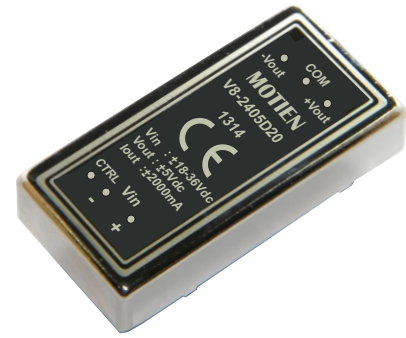

The V8 Series is a Series of high performance and high power density 20W single and dual output DC/DC converters. Encapsulated in a nickel coated copper case with the size of "2X1". Designed with high performance technology Active Clamp, high efficiency operation up to 93% and +/-1% output voltage accuracy. Precise controlled design provides tight line/load regulation. Various output voltages can be chosen from 3.3, 5, 12, 15, ±12, ±15Vdc.

ALL SPECIFICATIONS ARE TYPICAL AT 25°C, NOMINAL INPUT AND FULL LOAD UNLESS OTHERWISE NOTED.

OUTPUT SPECIFICATIONS		GENERAL SPECIFICATIONS	
Output Voltage Accuracy	±1%	Efficiency	See table, typ.
Output Voltage Adjustability(Trim)	Single output: ±10%, max.	I/O Isolation Voltage(60 sec)	
Maximum Output Current	See table	Input/Output	1600Vdc
Line Regulation	±0.5%, max.	Case/Input & Output	1600Vdc
Load Regulation(I _o =0% to 100%)	Single: ±0.5%, max. Dual:±1%, max(balanced load)	Isolation Resistance	1000 MΩ, min.
Cross Regulation (Dual Output) (1)	±5%	Isolation Capacitance	1200 pF, typ.
Ripple&Noise (2)	75mVp-p, max.	Switching frequency	330kHz, typ.
	3.3V output 3.9V	Humidity	95% rel H
	5V output 6.2V	Reliability Calculated MTBF(MIL-HDBK-217 F)	>684 khrs
Over Voltage Protection	12V output 15V	Safety Standard (designed to meet)	IEC/EN 60950-1
(Zener diode clamp)	15V output 18V		
	±12V output ±15V		
	±15V output ±18V		
Over Current Protection	140% of FL, typ.	EMC CHARACTERISTICS	
Short Circuit Protection	Indefinite(hiccup) (Automatic Recovery)	Radiated Emissions	EN55022 CLASS A
Temperature Coefficient	±0.02%/°C	Conducted Emissions(7)	EN55022 CLASS A
Capacitive Load (3)	See table	ESD	IEC61000-4-2 Perf. Criteria A
Transient Recovery Time (4)	250us, typ.	RS	IEC61000-4-3 Perf. Criteria A
Transient Response Deviation(4)	±3%, max.	EFT(8)	IEC61000-4-4 Perf. Criteria A
		Surge (8)	IEC61000-4-5 Perf. Criteria A
		CS	IEC61000-4-6 Perf. Criteria A
		PFMF	IEC61000-4-8 Perf. Criteria A
INPUT SPECIFICATIONS		PHYSICAL SPECIFICATIONS	
Input Voltage Range	See table	Case Material	Nickel-coated Copper
Under Voltage Lockout		Base Material	Non-conductive Black Plastic(UL94V-0 rated)
12V Models Module ON / OFF	8.6Vdc / 7.9Vdc, typ.	Pin Material	Φ1.0mm Brass Solder-coated
24V Models Module ON / OFF	17.8Vdc / 16Vdc, typ.	Potting Material	Epoxy (UL94V-0 rated)
48V Models Module ON / OFF	33.5Vdc / 30.5Vdc, typ.	Weight	30.0g
Start up Time	20mS, typ.	Dimensions	2.00"x1.00"x0.40"
(Nominal Vin and constant resistive load)			
Input Filter	Pi Type	ABSOLUTE SPECIFICATIONS (9)	
Input Current(No-Load)	See table, typ.	These are stress ratings. Exposure of devices to any of these conditions may adversely affect long-term reliability.	
Input Current(Full-Load)	See table, max.	Input Surge Voltage(100mS)	
Input Reflected Ripple Current(5)	20mA _{p-p} , typ.	12 Models	36 Vdc max.
Remote On/Off (CTRL)(6)		24 Models	50 Vdc max.
ON: 3.0 ... 12Vdc or open circuit		48 Models	100 Vdc max.
OFF: 0 ... 1.2Vdc or Short circuit pin2 and pin 6		Soldering Temperature	260°C max.
OFF idle current: 5 mA, typ		(1.5mm from case 10 sec. Max.)	
ENVIRONMENTAL SPECIFICATIONS			
Operating Ambient Temperature	-40°C ~ +85°C(See Derating Curve) -40°C ~ +70°C(For 100% load)		
Maximum Case Temperature	100°C		
Storage Temperature	-55°C ~ +125°C		
Cooling	Nature Convection		

The information and specifications contained in this data sheet are believed to be correct at time of publication. However, MOTIEN Technologies accepts no responsibility for consequences arising from printing errors or inaccuracies. Specifications are subject to change without notice. No rights under any patent accompany the sale of any such product(s) or information contained herein.

V8 - 20W 2:1 Regulated Single & Dual output

PART NUMBER STRUCTURE

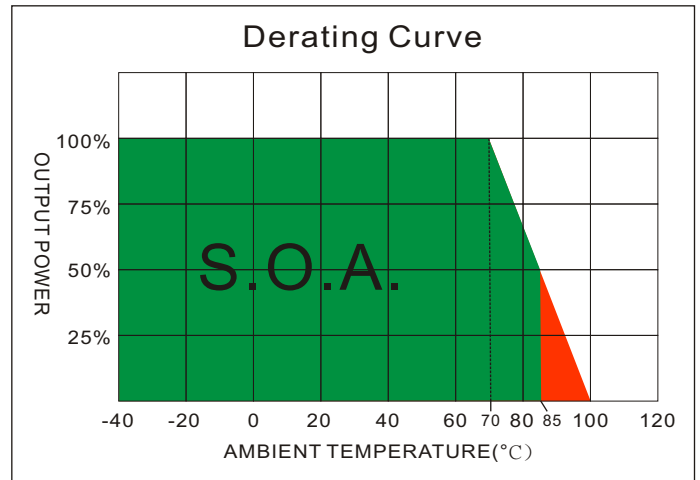
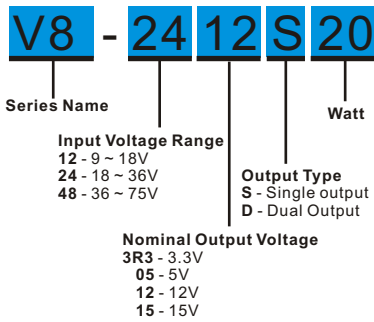

MODEL SELECTION GUIDE

MODEL NUMBER	INPUT Voltage Range (Vdc)	INPUT Current		OUTPUT Voltage (Vdc)	OUTPUT Current		EFFICIENCY @FL(%)	Capacitor Load(uF)
		No-Load (mA)	Full Load (mA)		Min. load (mA)	Full load (mA)		
V8-123R3S20	9-18	60	1738	3.3	0	5500	90	10000
V8-1205S20	9-18	60	1872	5	0	4000	92	6800
V8-1212S20	9-18	30	1915	12	0	1670	90	1000
V8-1215S20	9-18	30	1915	15	0	1330	90	680
V8-243R3S20	18-36	35	859	3.3	0	5500	91	10000
V8-2405S20	18-36	35	926	5	0	4000	93	6800
V8-2412S20	18-36	25	946	12	0	1670	91	1000
V8-2415S20	18-36	25	947	15	0	1330	91	680
V8-483R3S20	36-75	25	425	3.3	0	5500	91	10000
V8-4805S20	36-75	25	463	5	0	4000	93	6800
V8-4812S20	36-75	15	473	12	0	1670	91	1000
V8-4815S20	36-75	15	473	15	0	1330	91	680
V8-1212D20	9-18	30	1937	±12	0	±835	89	±470
V8-1215D20	9-18	30	1937	±15	0	±665	89	±330
V8-2412D20	18-36	30	957	±12	0	±835	90	±470
V8-2415D20	18-36	30	957	±15	0	±665	90	±330
V8-4812D20	36-75	20	478	±12	0	±835	90	±470
V8-4815D20	36-75	20	484	±15	0	±665	89	±330

NOTE

- One load is 25% to 100% load, the other load is 100% load, the output voltage variable rate is within ±5%.
- Measured with 20MHz bandwidth and 1.0uF ceramic capacitor.
- Tested by minimal Vin and constant resistive load.
- Tested by normal Vin and 25% load step change (75%-50%-25% of Io).
- Measured Input reflected ripple current with a simulated source inductance of 12uH.
- The remote on/off control pin is referenced to -Vin(pin2).
- Input filter components (C1, L) are used to help meet conducted emissions requirement for the module.
These components should be mounted as close as possible to the module; and all leads should be minimized to decrease radiated noise.
- An external filter capacitor is required if the module has to meet IEC61000-4-4 and IEC61000-4-5.
The filter capacitor Motien suggest: Nippon chemi-con KY series, 220uF/100V.
- Exceeding the absolute ratings of the unit could cause damage.

TEST CONFIGURATIONS

Input Reflected Ripple Current Test Step

Input reflected ripple current is measured through a source inductor L_{in} (12uH) and a source capacitor C_{in} (47uF, ESR<1.0Ω at 100KHz) at nominal input and full load.

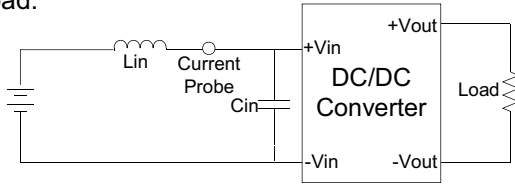

Output Ripple & Noise Measurement Test

Use a capacitor C_{out} (1.0uF) measurement. The Scope measurement bandwidth is 0-20MHz.

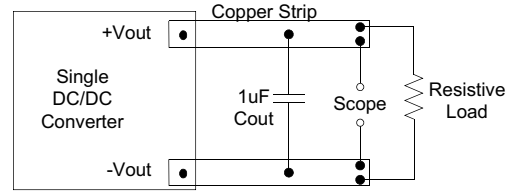

DESIGN&FEATURE CONFIGURATIONS

CTRL Module ON / OFF

Positive logic turns on the module during high logic and off during low logic.

Ctrl module on/off can be controlled by an external switch between the ctrl terminal and -Vin terminal. The switch can be an open collector or open drain.

For positive logic if the ctrl feature is not used, please leave the ctrl pin floating.

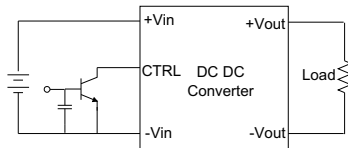

EMI Filter

Input filter components (C_1 , L) are used to help meet conducted emissions requirement for the module. These components should be mounted as close as possible to the module; and all leads should be minimized to decrease radiated noise.

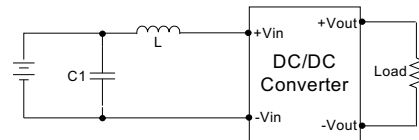

	C1	L
V8-12XXXXX	220uF/100V	12uH
V8-24XXXXX	220uF/100V	12uH
V8-48XXXXX	220uF/100V	12uH

ELECTRICAL CHARACTERISTIC CURVES

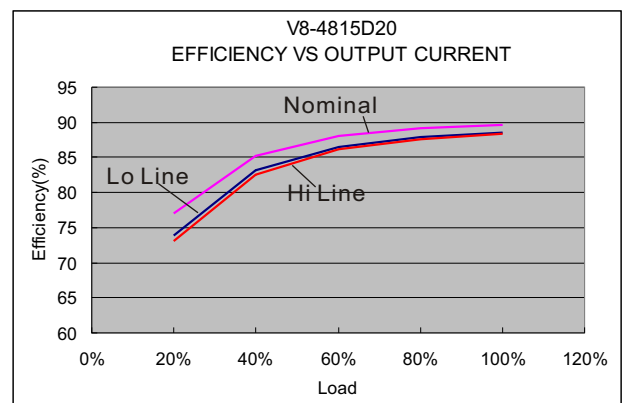
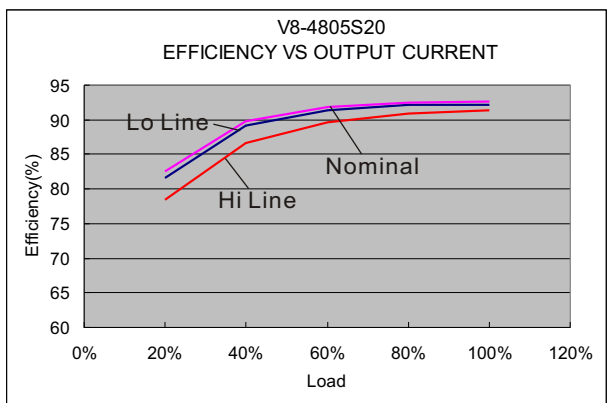
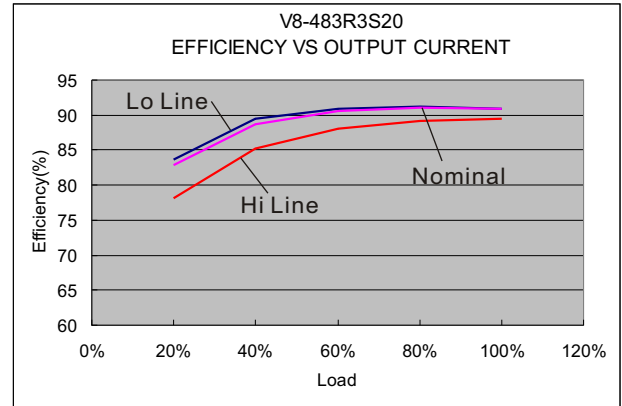
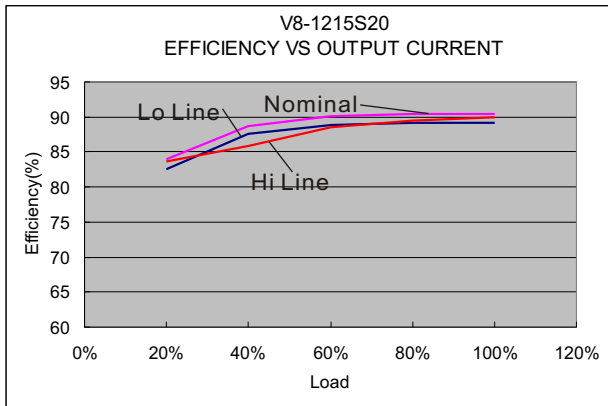

The models listed above is just for standard type. If you need the special specification product, please contact our service member by telephone presented in shortform cover or e-mail to : sales@motien.com.tw

MECHANICAL SPECIFICATIONS

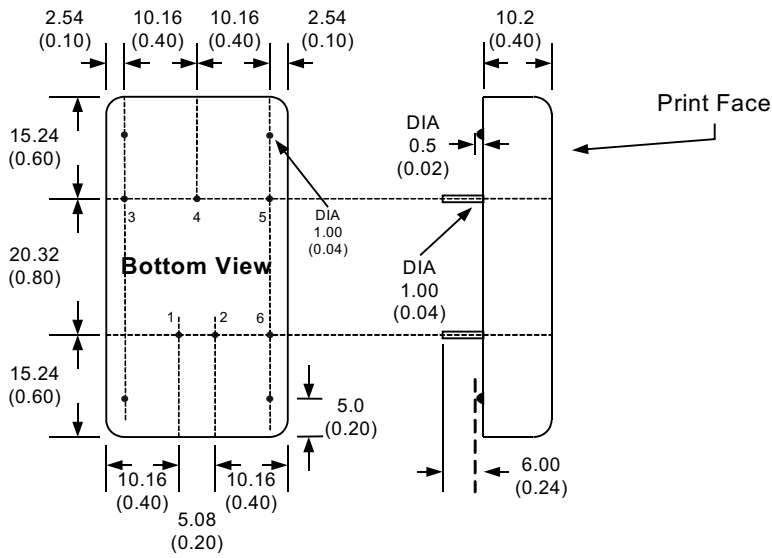

PIN CONNECTIONS

PIN NUMBER	SINGLE	DUAL
1	+Vin	+Vin
2	-Vin	-Vin
3	+Vout	+Vout
4	Trim	Com
5	-Vout	-Vout
6	CTRL	CTRL

EXTERNAL OUTPUT TRIMMING

Output can be externally trimmed by using the method as below. (single output models only)

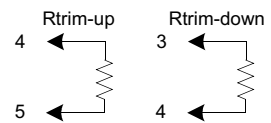

All dimensions are typical in millimeters (inches).

1. Pin diameter: 1.0 ±0.05 (0.04 ±0.002)
2. Pin pitch and length tolerance: ±0.35 (±0.014)
3. Case Tolerance: ±0.5 (±0.02)
4. Stand-off tolerance: ±0.1 (±0.004)