

MDL48 Series

High Efficiency Step Down LED Driver



Features

- RoHS-compliant 24 Pin DIL Package
- Constant Current Output (±7% Output Current Accuracy)
- LED Driver Current 150 / 250 / 300 / 350 / 500 / 600 / 700 / 1000mA
- Power LED Driver
- Wide Input Voltage Range: 7V to 60V (65V for 0.5sec.)
- Output Power 9 / 14 / 17 / 20 / 29 / 34 / 40 / 48W
- Driver LED Strings of up to 57V (2V to 57V)
- High Efficiency (up to 97%)
- PWM/Digital Dimming and Analog Voltage Dimming
- Open and Short LED Protection
- -40°C ~ 85°C Operation Temperature Range
- With MLCC Capacitors only



Application

- 12V, 24V, 36V and 48V Lighting Systems
- Household/Commercial lighting
- Suitable for high illumination LED
- Power limited (battery) lighting system

MDL48 Series is a high efficiency step-down converter optimized to drive high current LEDs. The control algorithm allows highly efficient and accurate LED current regulation. The device operates from an input 7Vdc to 60Vdc and provides an externally adjustable output current of up to 1000mA and output power up to 48 watts. Compact size of DIL24 allows designer to integrate this driver together with LED module. UL 94V-0 grade molded case with high grade filling material provide excellent fire proof characters.

(Typical at Ta = +25°C, nominal input voltage, rated output current unless otherwise specified.)

Electrical Specifications:	
Input Voltage (Vdc)	7V ~ 60V, 48Vdc Nominal
Input Filter	Capacitor
Output Voltage Range (Vin = 60V)	2V to 57V
Output Current Range (Vin - Vout > 3V)	See table
Output Current Accuracy	See table
Output Power	See table
Ripple and Noise, (20 MHz bandwidth)	See table
Maximum Efficiency at Full Load	97%
Capacitive Load	470uF
Operating Frequency	20 kHz ~ 500 kHz
Short Circuit Protection	Regulated at Rated Output Current
Temperature Coefficient	±0.03%/°C, max.
Thermal Impedance (Nature Convection)	+30°C/W
Safety Standard : (designed to meet)	IEC / EN 60950-1

Environmental Specifications	
Operating Temperature Range	-40°C to +85°C (See Derating Curve)
Storage Temperature Range	-40°C to +125°C
Humidity	95% rel H
Maximum Case Temperature	+110°C
Cooling	Nature Convection
Reliability Calculated MTBF (MIL-HDBK-217 F)	>950 Khrs
Soldering Temperature (1.5mm from case 10 sec. max.)	+260°C, max.

Physical Specifications	
Case Material	Non-Conductive Black Plastic (UL94V-0 rated)
Potting Material	Epoxy (UL94V-0 rated) Silicon (UL94V-0 rated)
Pin Material	Ø0.5mm Brass Solder-coated
Weight	17.7g
Dimensions	1.25"x0.80"x0.49"

Dimming Control and ON/OFF Control (Leave Open if Not Used):	
V _{ADJ} Pin Input Voltage Range	0V to 1.25V
V _{ADJ} Pin Drive Current (V _{ADJ} = 1.25V)	<1mA
Analog Dimming	
Adjust Output Current (Vin - Vout < 30V)	25% to 100%
Control Voltage Range Limits	
On	0.3V < V _{ADJ} < 1.25V
Off	V _{ADJ} < 0.15V
PWM Dimming	
Recommended Maximum Operation Frequency	1KHz
Adjust Output Current	0% to 100%
Remote ON/OFF	
DC/DC ON	0.3V < V _{ADJ} < 1.25V or open circuit
DC/DC OFF (Shutdown)	V _{ADJ} < 0.15V or Short circuit pin 2,3 and pin 4
Quiescent Input Current in Shutdown Mode (Vin = 60V)	100µA, max.

EMC SPECIFICATIONS	
EMI Radiated & Conducted Emissions	EN 55015 (CISPR22)
EMS Immunity EN61547	
IEC 61000-4-2	Perf. Criteria A
IEC 61000-4-3	Perf. Criteria A
IEC 61000-4-4	Perf. Criteria A
IEC 61000-4-5	Perf. Criteria A
IEC 61000-4-6	Perf. Criteria A
IEC 61000-4-8	Perf. Criteria A

NOTE

1. Reversed power source damages the circuit, No connection is allowed between input ground and output.
2. DO NOT operate the driver over output power.
3. Leave pin V_{ADJ} open if not in use, ground pin to shut down the converter. Connecting V_{ADJ} to Vin damages the circuit.
4. Maximum output open voltage is equal to input voltage.
5. Input filter components (C1, C2, L, C3) are used to help meet conducted emissions requirement for the module.
6. The test Conditions of IEC 61000-4-5 is ±0.5kV input DC power ports.

The information and specifications contained in this data sheet are believed to be correct at time of publication. However, MOTIEN Technologies accepts no responsibility for consequences arising from printing errors or inaccuracies. Specifications are subject to change without notice. No rights under any patent accompany the sale of any such product(s) or information contained herein.

PART NUMBER STRUCTURE

MDL48 - 60 - 1000

Series Name

Input Max. Voltage

Output Current
 150 - 150mA
 250 - 250mA
 300 - 300mA
 350 - 350mA
 500 - 500mA
 600 - 600mA
 700 - 700mA
 1000 - 1000mA

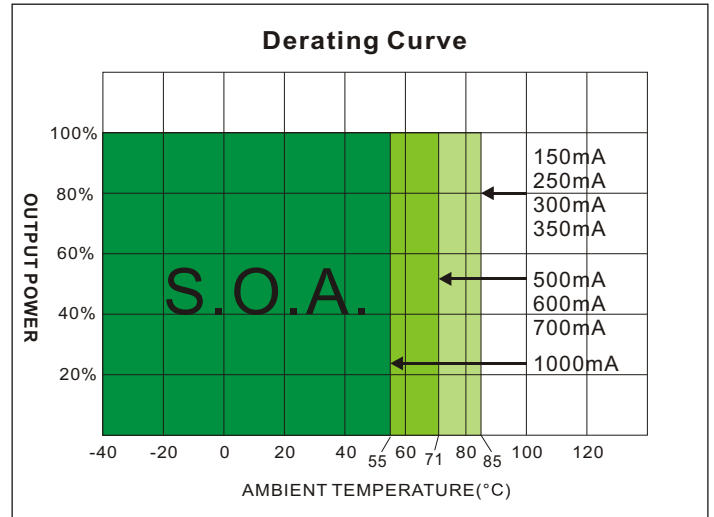

MODEL SELECTION GUIDE

MODEL NUMBER	INPUT	OUTPUT		OUTPUT Current	OUTPUT	EFFICIENCY @FL(%) Max.	Ripple and Noise mVp-p Max.	Capacitor Load(uF)
	Voltage Range (Vdc)	Voltage Range (Vdc)	Current (mA)	Accuracy (%)	Power (W) Max.			
MDL48-60-150	7-60	2 ~57	150	±8	9	60 - 97	150	470
MDL48-60-250	7-60	2 ~57	250	±7	14	65 - 97	200	470
MDL48-60-300	7-60	2 ~57	300	±6	17	67 - 97	250	470
MDL48-60-350	7-60	2 ~57	350	±5	20	66 - 97	300	470
MDL48-60-500	7-60	2 ~57	500	±5	29	69 - 97	400	470
MDL48-60-600	7-60	2 ~57	600	±5	34	69 - 97	450	470
MDL48-60-700	7-60	2 ~57	700	±5	40	69 - 97	500	470
MDL48-60-1000	7-60	2 ~48	1000	±5	48	64 - 97	800	470

MECHANICAL DIMENSION

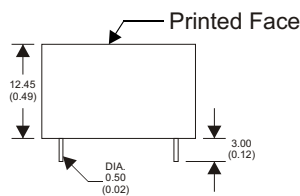
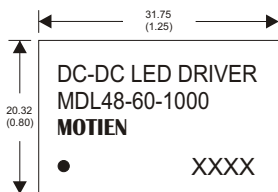

24 Pin DIL Package

- Notes : All dimensions are typical in millimeters (inches).
 1. Pin diameter: 0.5±0.05 (0.02±0.002)
 2. Pin pitch and length tolerance: ±0.35 (±0.014)
 3. Case Tolerance: ±0.5 (±0.02)

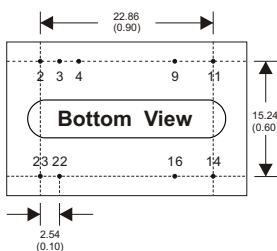

Recommended Footprint Details

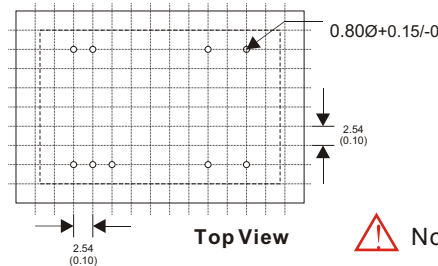

Pin #	CONNECTIONS	
2,3	- V Input	- DC Supply
4	VADJ	PWM/ON/OFF or not used
9,11	- V Output	LED Cathode Connection
14,16	+V Output	LED Anode Connection
22,23	+V Input	+DC Supply

No connection is allowed between input and output

The information and specifications contained in this data sheet are believed to be correct at time of publication. However, MOTIEN Technologies accepts no responsibility for consequences arising from printing errors or inaccuracies. Specifications are subject to change without notice. No rights under any patent accompany the sale of any such product(s) or information contained herein.

Typical Operating Conditions

MDL48-60-150

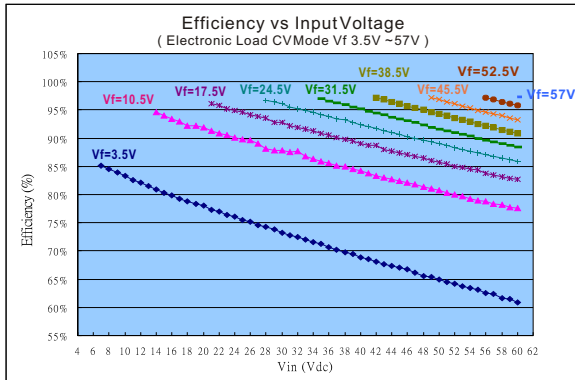

MDL48-60-500

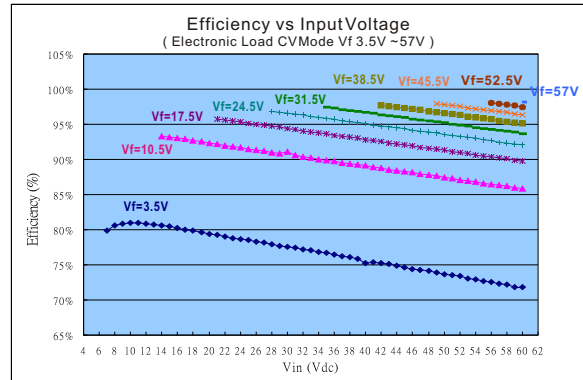

MDL48-60-250

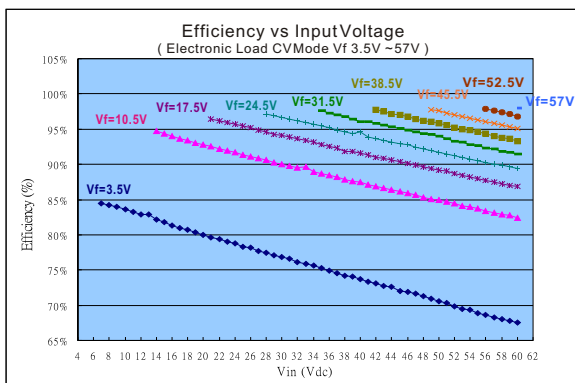

MDL48-60-600

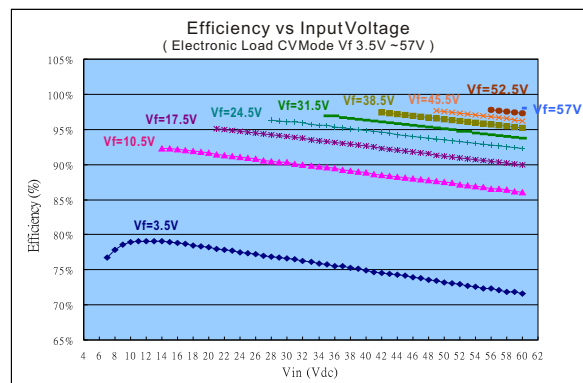

MDL48-60-300

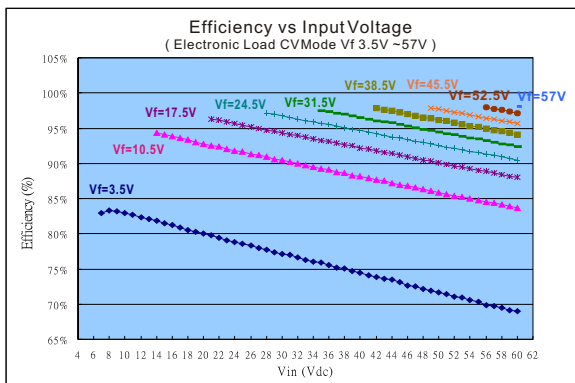

MDL48-60-700

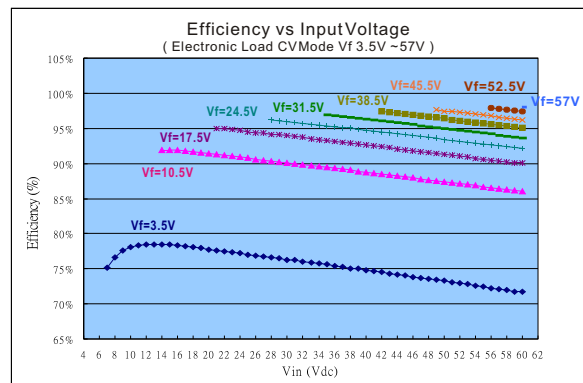

MDL48-60-350

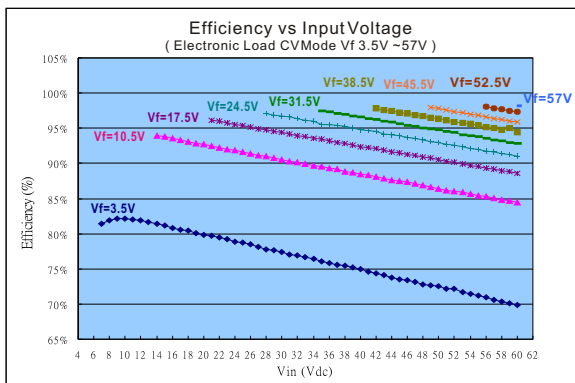

MDL48-60-1000

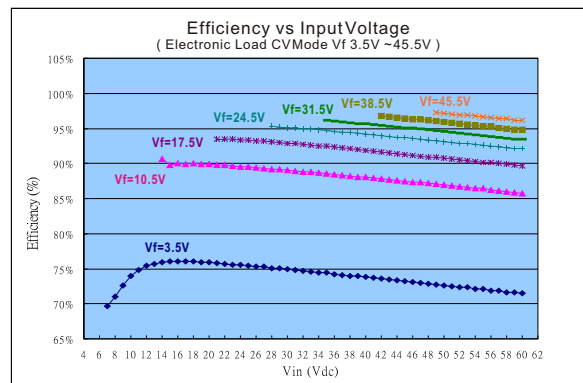

The information and specifications contained in this data sheet are believed to be correct at time of publication. However, MOTIEN Technologies accepts no responsibility for consequences arising from printing errors or inaccuracies. Specifications are subject to change without notice. No rights under any patent accompany the sale of any such product(s) or information contained herein.

EMC Characteristics meet EN55022

EMC Countermeasures Suggestion

Input filter components (C1, C2, L, C3) are used to help meet conducted emissions requirement for the module. These components should be mounted as close as possible to the module; and all leads should be minimized to decrease radiated noise.

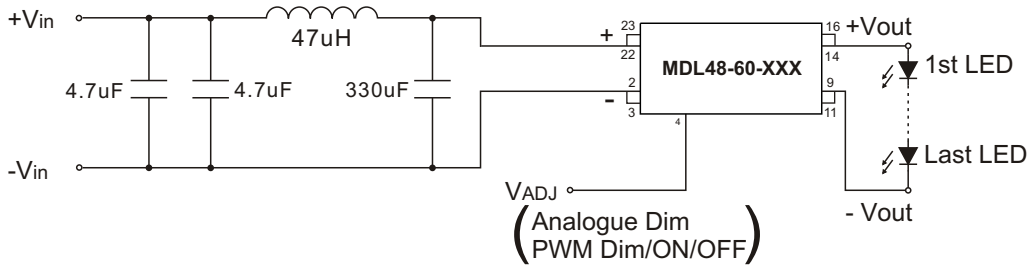

Conducted Emissions Test

Vin=60V Vout=30V(LED Load Vf=3.3V , 9LED ≐ 30V)

Vin=12V Vout=3.3V(LED Load Vf=3.3V , 1LED ≐ 30V)

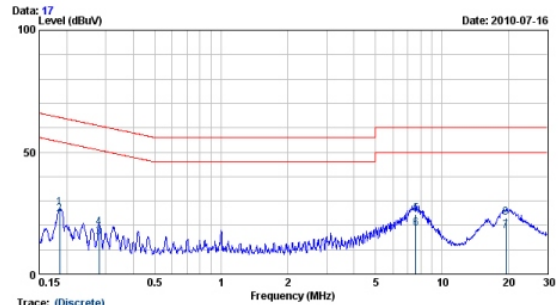
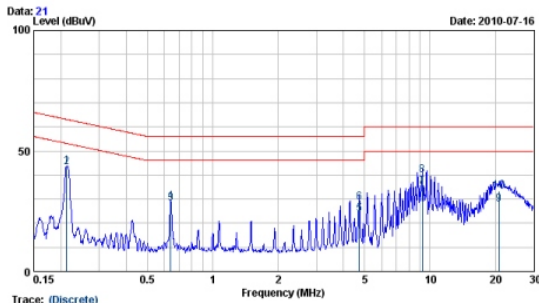

Freq. MHz	LISN Factor dB	Cable Loss dB	Meter Reading dBuV	Measured Level dBuV	Limits dBuV	Over Limits dBuV	Detector
0.213	9.93	0.03	33.77	43.73	63.10	-19.36	QP
0.213	9.93	0.03	33.37	43.33	53.10	-9.76	AVERAGE
0.641	9.95	0.06	18.14	28.15	46.00	-17.85	AVERAGE
0.641	9.95	0.06	18.84	28.85	56.00	-27.15	QP
4.721	9.96	0.06	13.66	23.68	46.00	-22.32	AVERAGE
4.721	9.96	0.06	18.66	28.68	56.00	-27.32	QP
9.212	110.01	0.07	24.91	34.99	50.00	-15.01	AVERAGE
9.212	110.01	0.07	29.72	39.80	60.00	-20.20	QP
20.814	110.04	0.12	17.76	27.91	50.00	-22.09	AVERAGE
20.814	110.04	0.12	23.23	33.38	60.00	-26.62	QP

Freq. MHz	LISN Factor dB	Cable Loss dB	Meter Reading dBuV	Measured Level dBuV	Limits dBuV	Over Limits dBuV	Detector
0.185	9.92	0.04	16.97	26.92	64.24	-37.32	QP
0.185	9.92	0.04	14.56	24.51	54.24	-29.73	AVERAGE
0.280	9.95	0.04	9.09	19.09	60.81	-41.72	QP
7.606	9.99	0.08	14.56	24.63	60.00	-35.37	QP
7.606	9.99	0.08	8.70	18.77	50.00	-31.23	AVERAGE
19.428	110.03	0.10	7.33	17.46	50.00	-32.54	AVERAGE
19.428	110.03	0.10	12.82	22.95	60.00	-37.05	QP

REMARKS: 1.Level(dBuV/m)=Read Level(dBuV)+Antenna Factor(dB/m)+Cable loss(dB)
2.Over Limit value(dB)=Level(dBuV/m)-Limit Line(dBuV/m)

REMARKS: 1.Level(dBuV/m)=Read Level(dBuV)+Antenna Factor(dB/m)+Cable loss(dB)
2.Over Limit value(dB)=Level(dBuV/m)-Limit Line(dBuV/m)

Vin=60V Vout=48V(LED Load Vf=3.3V , 14LED ≐ 15V)

Vin=7V Vout=3.3V(LED Load Vf=3.3V , 1LED ≐ 30V)

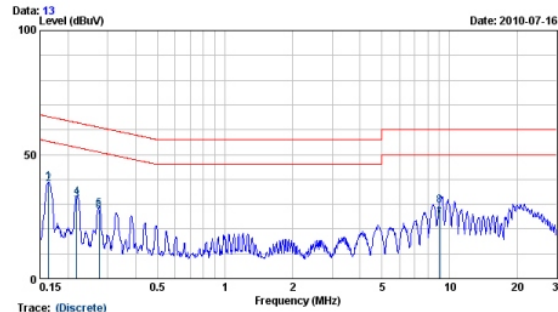
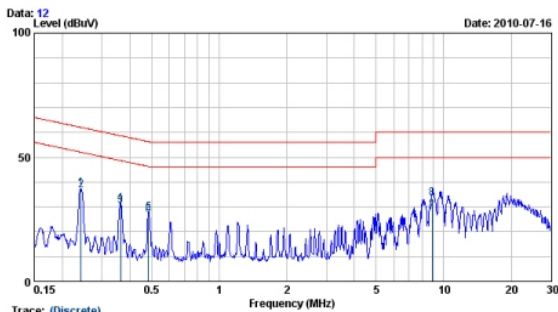

Freq. MHz	LISN Factor dB	Cable Loss dB	Meter Reading dBuV	Measured Level dBuV	Limits dBuV	Over Limits dBuV	Detector
0.242	9.94	0.04	27.29	37.27	62.04	-24.77	QP
0.242	9.94	0.04	26.56	36.54	52.04	-15.50	AVERAGE
0.363	9.95	0.05	20.52	30.52	48.65	-18.13	AVERAGE
0.363	9.95	0.05	21.22	31.22	58.65	-27.43	QP
0.484	9.94	0.06	17.42	27.42	56.27	-28.85	QP
0.484	9.94	0.06	16.58	26.58	46.27	-19.69	AVERAGE
8.869	110.00	0.07	17.71	27.79	50.00	-22.21	AVERAGE
8.869	110.00	0.07	23.20	33.28	60.00	-26.72	QP

Freq. MHz	LISN Factor dB	Cable Loss dB	Meter Reading dBuV	Measured Level dBuV	Limits dBuV	Over Limits dBuV	Detector
0.163	9.91	0.04	28.96	38.91	65.30	-26.38	QP
0.163	9.91	0.04	28.15	38.10	55.30	-17.19	AVERAGE
0.219	9.93	0.03	21.65	31.62	52.88	-21.26	AVERAGE
0.219	9.93	0.03	22.81	32.78	62.88	-30.10	QP
0.274	9.95	0.04	17.94	27.93	60.98	-33.05	QP
0.274	9.95	0.04	17.26	27.25	50.98	-23.73	AVERAGE
9.059	110.00	0.07	14.24	24.32	50.00	-25.68	AVERAGE
9.059	110.00	0.07	19.41	29.49	60.00	-30.51	QP

REMARKS: 1.Level(dBuV/m)=Read Level(dBuV)+Antenna Factor(dB/m)+Cable loss(dB)
2.Over Limit value(dB)=Level(dBuV/m)-Limit Line(dBuV/m)

REMARKS: 1.Level(dBuV/m)=Read Level(dBuV)+Antenna Factor(dB/m)+Cable loss(dB)
2.Over Limit value(dB)=Level(dBuV/m)-Limit Line(dBuV/m)

Typical Application

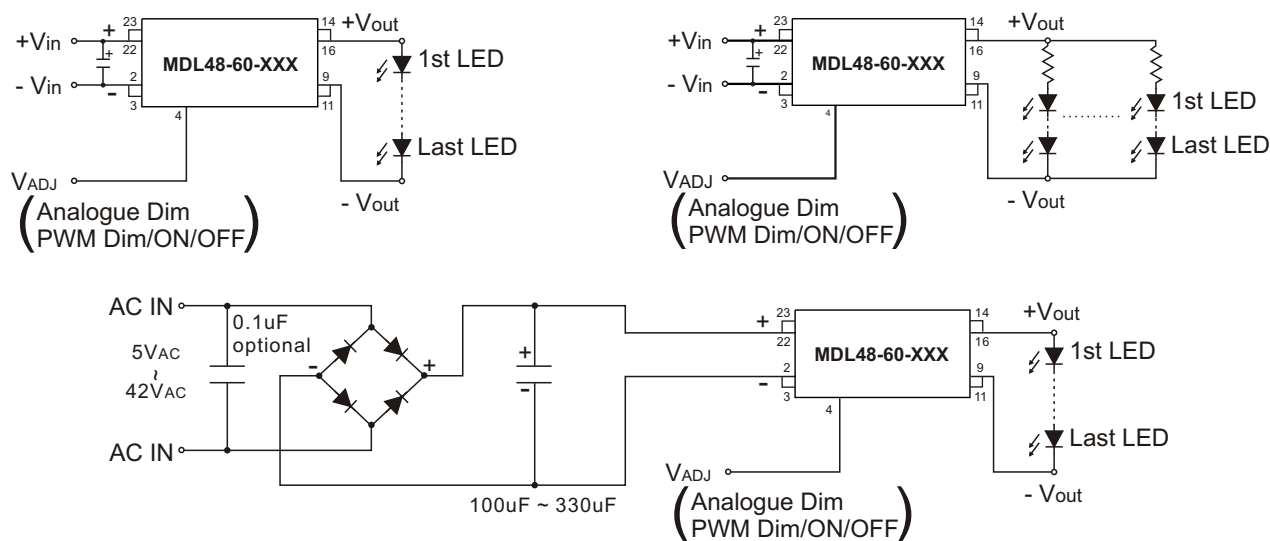

Output Current Adjustment By External DC Control Voltage (V_{CTRL})

$V_{ADJ} = V_{CTRL}$ [If $V_{CTRL} = 0 \sim 1.25V_{dc}$]

$V_{ADJ} = \frac{R2}{R1 + R2} \times V_{CTRL}$ [If $V_{CTRL} > 1.25 V_{dc}$]

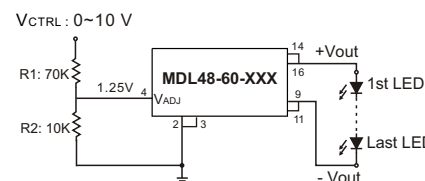
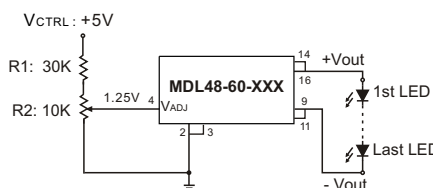
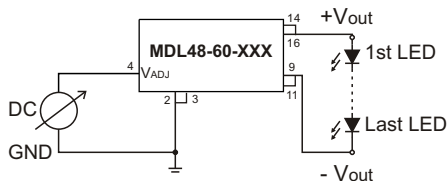

$V_{ADJ} = \frac{R3}{R2 + R3} \times 2.5$ [If $V_{CTRL} = V_{in}$]

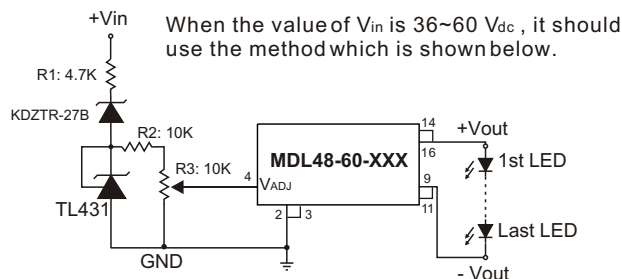
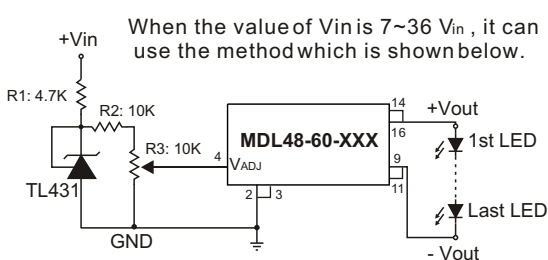

The nominal output current (I_{outnom}) is given by: $I_{outnom} \approx I_{out} \times \frac{V_{ADJ}}{1.25}$

Resistor dimming

By connecting a variable resistor between ADJ and GND, simple dimming can be achieved. Capacitor C_{ADJ} is optional for better AC mains interference and HF noise rejection. Recommend value of C_{ADJ} is 0.22uF.



The current output I_{outnom} can be determined using the equation:

$I_{outnom} = \frac{I_{out} \times R_{ADJ}}{(R_{ADJ} + 50K)}$

If the value of R_{ADJ} is 0 to 2M ohm, the maximum adjust range of output current is 25% to 90%. (For $V_{in} - V_{out} < 30V$)

The information and specifications contained in this data sheet are believed to be correct at time of publication. However, MOTIEN Technologies accepts no responsibility for consequences arising from printing errors or inaccuracies. Specifications are subject to change without notice. No rights under any patent accompany the sale of any such product(s) or information contained herein.

Typical Application

Output Current Adjustment By PWM Control

Directly driving ADJ input

A Pulse Width Modulated (PWM) signal with duty cycle D_{PWM} can be applied to the ADJ pin, as shown below

$$I_{out_{nom}} \approx I_{out} \times D_{PWM} \quad [\text{If PWM frequency} < 200\text{Hz, for } 0.1 < D_{PWM} < 1]$$

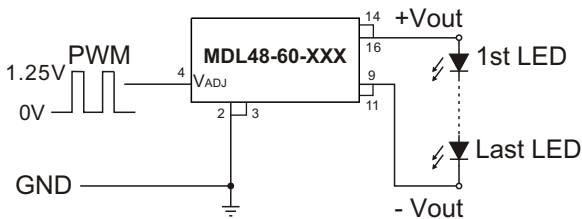

Driving the ADJ input via open collector transistor

The diode and resistor suppress possible high amplitude negative spikes on the ADJ input resulting from the drain-source capacitance of the transistor. Negative spikes at the input to the device should be avoided as they may cause errors in output current, or erratic device operation.

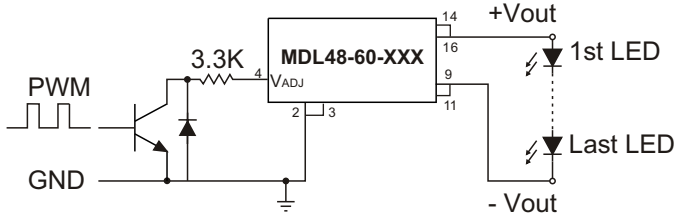

Driving the ADJ input from a microcontroller

Another possibility is to drive the device from the open drain output of a microcontroller. The diagram below shows one method of doing this:

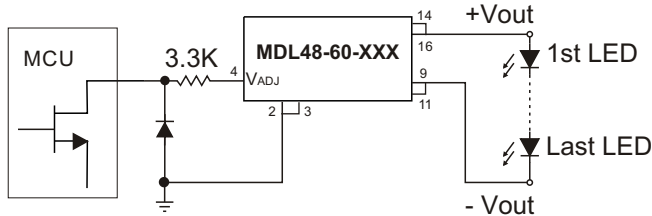

The diode and resistor suppress possible high amplitude negative spikes on the ADJ input resulting from the drain-source capacitance of the FET. Negative spikes at the input to the device should be avoided as they may cause errors in output current, or erratic device operation.

Output Current Adjustment By PWM Control (Dimming)

To avoid visible flicker the PWM signal must be greater than 100Hz.

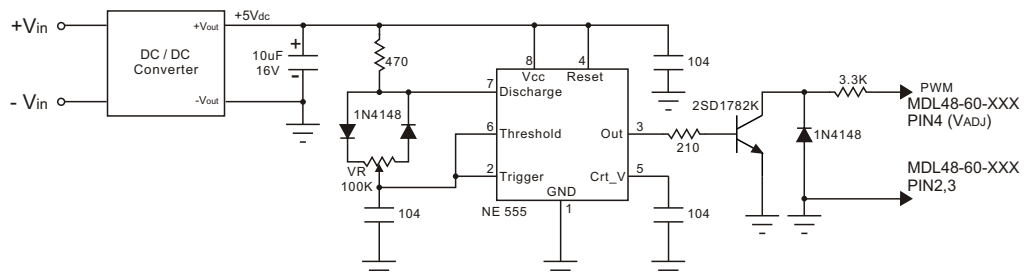

Output Current Adjustment By PWM Control (Flash)

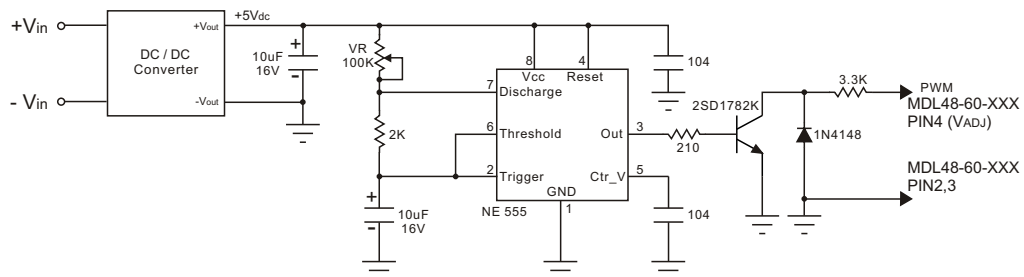

The information and specifications contained in this data sheet are believed to be correct at time of publication. However, MOTIEN Technologies accepts no responsibility for consequences arising from printing errors or inaccuracies. Specifications are subject to change without notice. No rights under any patent accompany the sale of any such product(s) or information contained herein.