

VQ-4W Series

4W 4:1 Regulated Single & Dual output



Features

- Wide 4:1 Input Range
- Full SMD Technology
- 1500 VDC Isolation, Up to 3500 VDC
- Continuous Short Circuit Protection
- Efficiency up to 82%
- -40 ~ 85°C Operation Temperature Range
- Metal Case Standard, Optional Plastic Case



The VQ series is a family of cost effective 4W single & dual output DC-DC converters. These converters are consisted with Nickel-coated copper in a 24-pin DIL package with high performance features such as 1500 VDC ~ 3500VDC input/output isolation voltage, continuous short circuit protection with automatic restart and tight line / load regulation. Devices are encapsulated using flame retardant resin. Input voltages of 24 and 48 with output voltage of 3.3, 5, 7.2, 9, 12, 15, 24, ± 3.3 , ± 5 , ± 7.2 , ± 9 , ± 12 , ± 15 and ± 24 Vdc. High performance features include high efficiency operation up to 82% and output voltage accuracy of $\pm 1\%$ maximum.

All specifications typical at Ta=25°C, nominal input voltage and full load unless otherwise specified

OUTPUT SPECIFICATIONS	
Voltage accuracy	$\pm 1\%$
Line regulation	$\pm 0.5\%$
Load regulation(Io=0% to 100%)	$\pm 0.5\%$
(Output 3.3V / $\pm 3.3V$ Model)	$\pm 1.5\%$
Ripple & noise(20 MHz bandwidth)(1)	60mV pk-pk
Short circuit protection	Indefinite(Automatic Recovery)
Temperature coefficient	$\pm 0.02\%/^{\circ}\text{C}$
Capacitor load(2)	See table

INPUT SPECIFICATIONS	
Voltage Range	See table
Max. Input Current	See table
No-Load Input Current	See table
Input Filter	PI Type
Input Reflected Ripple Current(3)	35mA pk-pk

GENERAL SPECIFICATIONS	
Efficiency	See table, typ.
I/O Isolation Voltage(3 sec)	
Input/Output	1500~3500Vdc
Metal Case/Input & Output	1000Vdc
I/O Isolation Capacitance	470 pF typ.
I/O Isolation Resistance	1000M Ohm
Switching Frequency	Typical 266kHz
Humidity	95% rel H
Reliability Calculated MTBF(MIL-HDBK-217 F)	>1.121 Mhrs
Safety Standard : (designed to meet)	IEC 60950-1

PHYSICAL SPECIFICATIONS	
Case Material	Nickel-coated Copper
	Non-conductive Black Plastic(UL94V-0 rated)
Base Material	Non-conductive Black Plastic(UL94V-0 rated)
Pin Material	$\varnothing 0.5\text{mm}$ Brass Solder-coated
Potting Material	Epoxy (UL94V-0 rated)
Weight	17.0g(Metal Case)/13.5g(Plastic Case)
Dimensions	1.25"x0.8"x0.4"

ENVIRONMENT SPECIFICATIONS	
Operating Temperature	-40°C~85°C(See Derating Curve)
Maximum Case Temperature	100°C
Storage Temperature	-40°C~125°C
Cooling	Nature Convection

ABSOLUTE MAXIMUM RATINGS(4)	
These are stress ratings. Exposure of devices to any of these conditions may adversely affect long-term reliability.	
Input Surge Voltage(100mS)	
24 Models	40 Vdc max.
48 Models	80 Vdc max.
Soldering Temperature	260°C ,max.
(1.5mm from case 10sec. max.)	

EMC SPECIFICATIONS		
Radiated Emissions	EN55022	CLASS A
Conducted Emissions (5)	EN55022	CLASS A
ESD	IEC 61000-4-2	Perf. Criteria A
RS	IEC 61000-4-3	Perf. Criteria A
EFT	IEC 61000-4-4	Perf. Criteria A
Surge (6)	IEC 61000-4-5	Perf. Criteria A
CS	IEC 61000-4-6	Perf. Criteria A
PFMF	IEC 61000-4-8	Perf. Criteria A

The information and specifications contained in this data sheet are believed to be correct at time of publication. However, MOTIEN Technologies accepts no responsibility for consequences arising from printing errors or inaccuracies. Specifications are subject to change without notice. No rights under any patent accompany the sale of any such product(s) or information contained herein.

VQ - 4W 4:1 Regulated Single & Dual output

PART NUMBER STRUCTURE

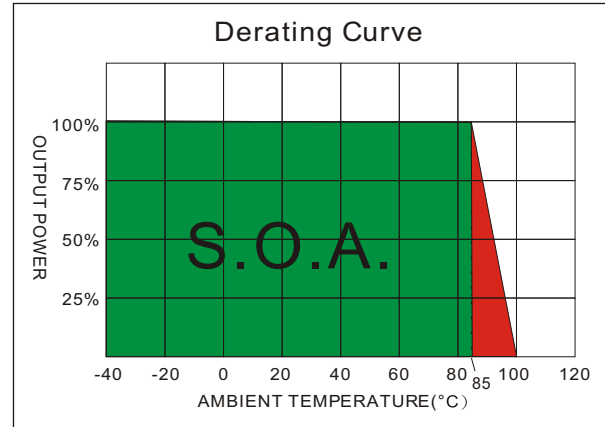
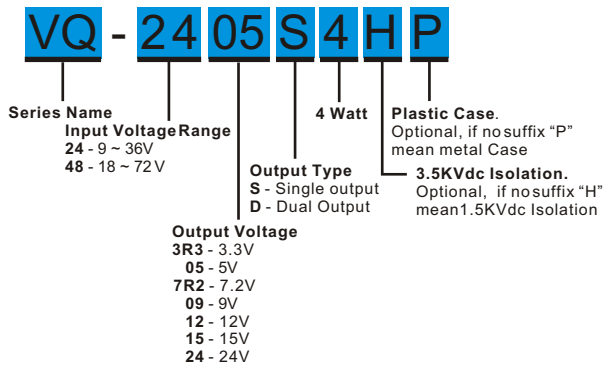

MODEL SELECTION GUIDE

MODEL NUMBER	INPUT Voltage Range (Vdc)	INPUT Current		OUTPUT Voltage (Vdc)	OUTPUT Current		EFFICIENCY @FL (%)	Capacitor Load (uF)
		No-Load (mA)	Full Load (mA)		Min. load (mA)	Full load (mA)		
VQ-243R3S4	9-36	18	222.0	3.3	0	1200	75	1000
VQ-24 05S4	9-36	18	210.9	5	0	800	79	680
VQ-247R2S4	9-36	18	208.3	7.2	0	555	80	100
VQ-24 09S4	9-36	18	208.3	9	0	444	80	100
VQ-24 12S4	9-36	18	203.3	12	0	333	82	100
VQ-24 15S4	9-36	18	203.3	15	0	266	82	100
VQ-24 24S4	9-36	18	205.8	24	0	166	81	100
VQ-243R3D4	9-36	18	222.0	±3.3	0	±606	75	±470
VQ-2405D4	9-36	18	210.9	±5	0	±400	79	±330
VQ-247R2D4	9-36	18	210.9	±7.2	0	±277	79	±47
VQ-2409D4	9-36	18	205.8	±9	0	±222	81	±47
VQ-2412D4	9-36	20	203.3	±12	0	±166	82	±47
VQ-2415D4	9-36	20	205.8	±15	0	±133	81	±22
VQ-2424D4	9-36	25	210.9	±24	0	±83	79	±10
VQ-483R3S4	18-72	15	110.0	3.3	0	1200	75	1000
VQ-48 05S4	18-72	15	105.5	5	0	800	79	680
VQ-487R2S4	18-72	15	102.8	7.2	0	555	81	680
VQ-48 09S4	18-72	15	104.2	9	0	444	80	220
VQ-48 12S4	18-72	15	101.6	12	0	333	82	220
VQ-48 15S4	18-72	15	101.6	15	0	266	82	68
VQ-48 24S4	18-72	15	104.2	24	0	166	80	47
VQ-483R3D4	18-72	15	108.2	±3.3	0	±606	77	±680
VQ-4805D4	18-72	15	105.5	±5	0	±400	79	±330
VQ-487R2D4	18-72	15	107.0	±7.2	0	±277	78	±47
VQ-4809D4	18-72	15	104.2	±9	0	±222	80	±47
VQ-4812D4	18-72	15	102.8	±12	0	±166	81	±47
VQ-4815D4	18-72	15	101.6	±15	0	±133	82	±33
VQ-4824D4	18-72	15	104.2	±24	0	±83	80	±22

Suffix "H" means 3.5KVdc isolation

Suffix "P" means Plastic case instead of standard Metal Case

NOTE

1. Ripple/Noise measured with a 1uF ceramic capacitor.
2. Test by nominal input voltage and constant resistor load.
3. Measured Input reflected ripple current with a simulated source inductance of 12uH.
4. Exceeding the absolute ratings of the unit could cause damage. It is not allowed for continuous operating.
5. It's recommended to add C1(220 uF), C3(1000PF,2KV), L(12uH) in input end to achieve EN55022 conducted Class A.
6. An external filter capacitor is required if the module has to meet IEC 61000-4-5. The filter capacitor Motien suggest: Nippon - chemi - con KY series, 220uF/100V.

TEST CONFIGURATIONS

Output Ripple & Noise Measurement Test

Use a capacitor Cout(1.0uF) measurement.
The Scope measurement bandwidth is 0-20MHz.

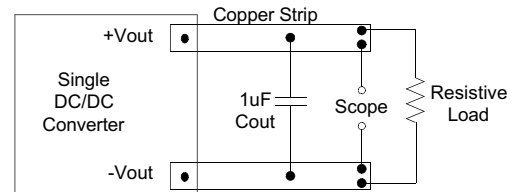

Input Reflected Ripple Current Test Step

Input reflected ripple current is measured through a source inductor Lin(12uH) and a source capacitor Cin(47uF, ESR<1.0Ω at 100KHz) at nominal input and full load.

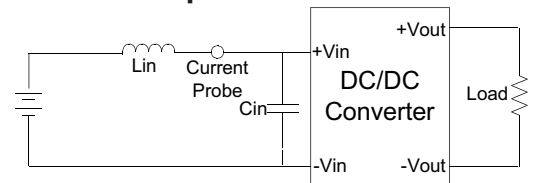

EMI Filter

Input filter components (C1,C3, L) are used to help meet conducted emissions requirement for the module. These components should be mounted as close as possible to the module; and all leads should be minimized to decrease radiated noise.

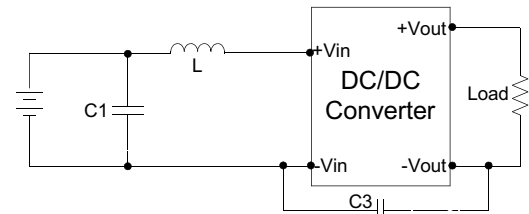

C1	L	C3
220uF, 100V	12uH	1000PF,2KV

ELECTRICAL CHARACTERISTIC CURVES

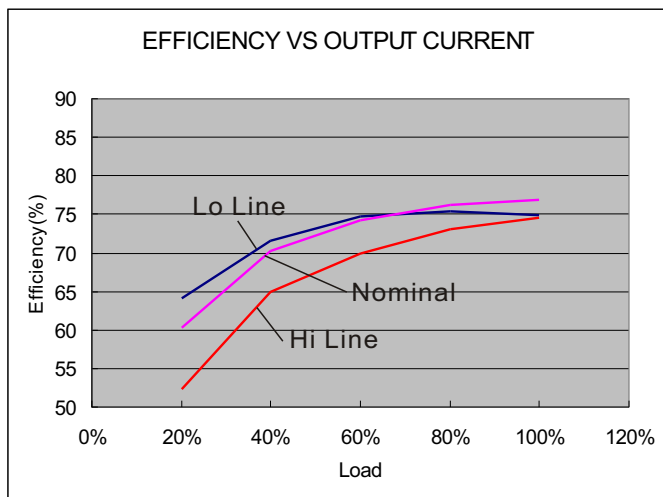

24 Models

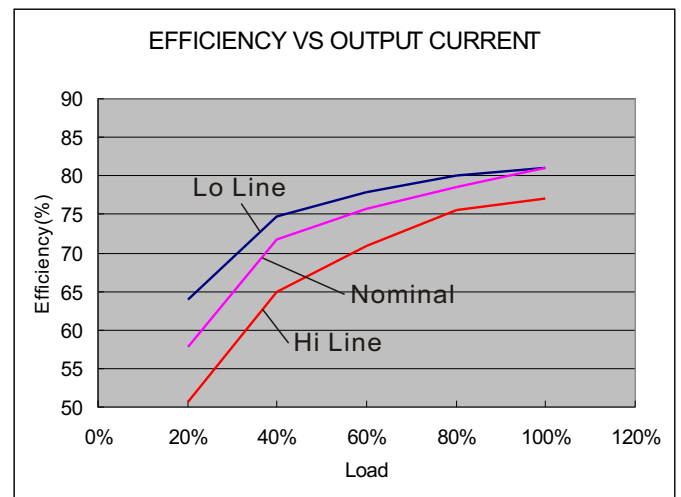

48 Models

The models listed above is just for standard type. If you need the special specification product, please contact our service member by telephone presented in shortform cover or e-mail to : sales@motien.com.tw

VQ - 4W 4:1 Regulated Single & Dual output

MECHANICAL SPECIFICATIONS

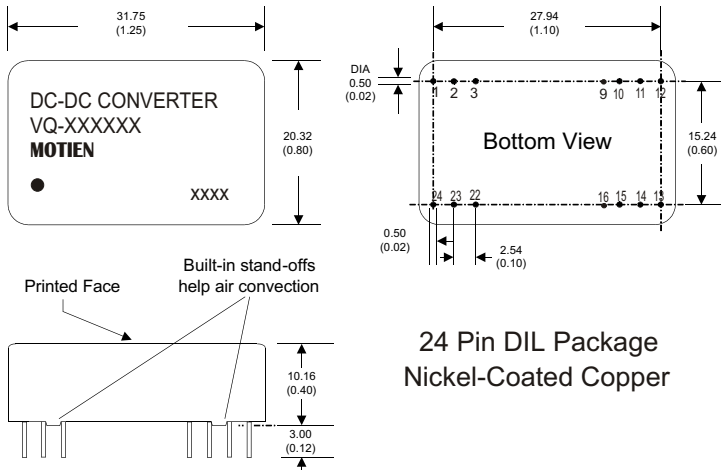

- Notes: All dimensions are typical in millimeters (inches).
1. Pin diameter: 0.5 ± 0.05 (0.02 ± 0.002)
 2. Pin pitch and length tolerance: ± 0.35 (± 0.014)
 3. Case Tolerance: ± 0.5 (± 0.02)

PIN CONNECTIONS				
PIN NUMBER	SINGLE	DUAL	SINGLE-H	DUAL-H
1	+V Input	+V Input	N.P.	N.P.
2	N.C.	-V Output	-V Input	-V Input
3	N.C.	Common	-V Input	-V Input
9	N.P.	N.P.	N.P.	Common
10	-V Output	Common	N.P.	N.P.
11	+V Output	+V Output	N.C.	-V Output
12	-V Input	-V Input	N.P.	N.P.
13	-V Input	-V Input	N.P.	N.P.
14	+V Output	+V Output	+V Output	+V Output
15	-V Output	Common	N.P.	N.P.
16	N.P.	N.P.	-V Output	Common
22	N.C.	Common	+V Input	+V Input
23	N.C.	-V Output	+V Input	+V Input
24	+V Input	+V Input	N.P.	N.P.

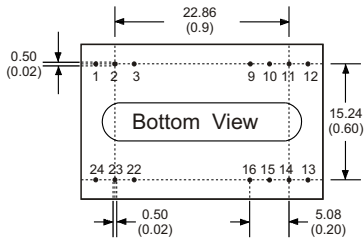
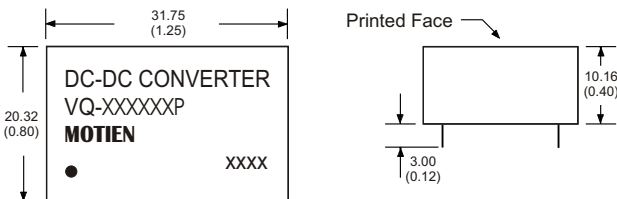

- Notes: All dimensions are typical in millimeters (inches).
1. Pin diameter: 0.5 ± 0.05 (0.02 ± 0.002)
 2. Pin pitch and length tolerance: ± 0.35 (± 0.014)
 3. Case Tolerance: ± 0.5 (± 0.02)

PIN CONNECTIONS				
PIN NUMBER	SINGLE	DUAL	SINGLE-H	DUAL-H
1	+V Input	+V Input	N.P.	N.P.
2	N.C.	-V Output	-V Input	-V Input
3	N.C.	Common	-V Input	-V Input
9	N.P.	N.P.	N.P.	Common
10	-V Output	Common	N.P.	N.P.
11	+V Output	+V Output	N.C.	-V Output
12	-V Input	-V Input	N.P.	N.P.
13	-V Input	-V Input	N.P.	N.P.
14	+V Output	+V Output	+V Output	+V Output
15	-V Output	Common	N.P.	N.P.
16	N.P.	N.P.	-V Output	Common
22	N.C.	Common	+V Input	+V Input
23	N.C.	-V Output	+V Input	+V Input
24	+V Input	+V Input	N.P.	N.P.