

VJ-4W Series

4W 4:1 Regulated Single & Dual output



Features

- Wide 4:1 Input Range
- Full SMD Technology
- 1500 VDC Isolation, Up to 3500 VDC
- Continuous Short Circuit Protection
- Efficiency up to 82%
- -40 ~ 85°C Operation Temperature Range
- Metal Case Standard, Optional Plastic Case



The VJ series is a family of cost effective 4W single & dual output DC-DC converters. These converters are consisted with Nickel-coated copper in a 24-pin DIL package with high performance features such as 1500 VDC ~ 3500VDC input/output isolation voltage, continuous short circuit protection with automatic restart and tight line / load regulation. Devices are encapsulated using flame retardant resin. Input voltages of 24 and 48 with output voltage of 3.3, 5, 9, 12, 15, 24, ± 3.3 , ± 5 , ± 9 , ± 12 , ± 15 and ± 24 Vdc. High performance features include high efficiency operation up to 82% and output voltage accuracy of $\pm 1\%$ maximum.

All specifications typical at Ta=25°C, nominal input voltage and full load unless otherwise specified

OUTPUT SPECIFICATIONS	
Voltage accuracy	$\pm 1\%$
Line regulation	$\pm 0.5\%$
Load regulation	$\pm 0.5\%$
	(Output 3.3V / $\pm 3.3V$ Model) $\pm 1.5\%$
Ripple & noise (20 MHz bandwidth)(1)	60mV pk-pk
Short circuit protection	Indefinite(Automatic Recovery)
Temperature coefficient	$\pm 0.02\%/^{\circ}C$
Capacitor load(2)	See table

INPUT SPECIFICATIONS	
Voltage Range	See table
Max. Input Current	See table
No-Load Input Current	See table
Input Filter	PI Type
Input Reflected Ripple Current(3)	35mA pk-pk

GENERAL SPECIFICATIONS	
Efficiency	See table, typ
I/O Isolation Voltage(3 sec)	
Input/Output	1500~3500Vdc
Metal Case/Input & Output	1000Vdc
I/O Isolation Capacitance	470 pF Typ.
I/O Isolation Resistance	1000M Ohm
Switching Frequency	Typical 266kHz
Humidity	95% rel H
Reliability Calculated MTBF(MIL-HDBK-217 F)	>1.121 Mhrs
Safety Standard : (designed to meet)	IEC 60950-1

PHYSICAL SPECIFICATIONS	
Case Material	Nickel-coated Copper
	Non-conductive Black Plastic(UL94V-0 rated)
Base Material	Non-conductive Black Plastic(UL94V-0 rated)
Pin Material	$\varnothing 0.5$ mm Brass Solder-coated
Potting Material	Epoxy (UL94V-0 rated)
Weight	17.0g(Metal Case)/13.5g(Plastic Case)
Dimensions	1.25"x0.8"x0.4"

ENVIRONMENT SPECIFICATIONS	
Operating Temperature	-40°C~85°C(See Derating Curve)
Maximum Case Temperature	100°C
Storage Temperature	-40°C~125°C
Cooling	Nature Convection

ABSOLUTE MAXIMUM RATINGS(4)	
These are stressratings. Exposure of devices to any of these conditions may adversely affect long-term reliability.	
Input Surge Voltage(100mS)	
24 Models	40 Vdc max.
48 Models	80 Vdc max.
Soldering Temperature	260°C max.
(1.5mm from case 10sec. max.)	

The information and specifications contained in this data sheet are believed to be correct at time of publication. However, MOTIEN Technologies accepts no responsibility for consequences arising from printing errors or inaccuracies. Specifications are subject to change without notice. No rights under any patent accompany the sale of any such product(s) or information contained herein.

VJ - 4W 4:1 Regulated Single & Dual output

PART NUMBER STRUCTURE

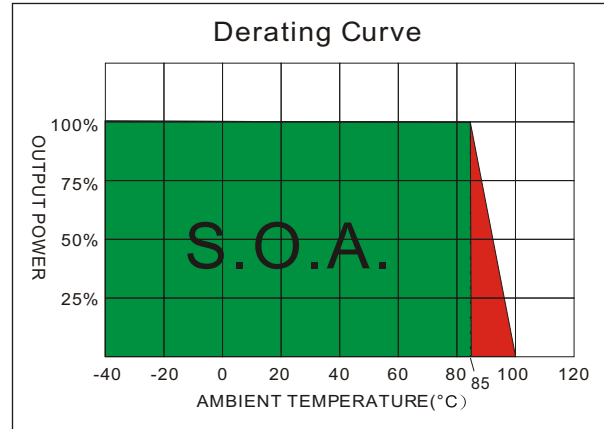
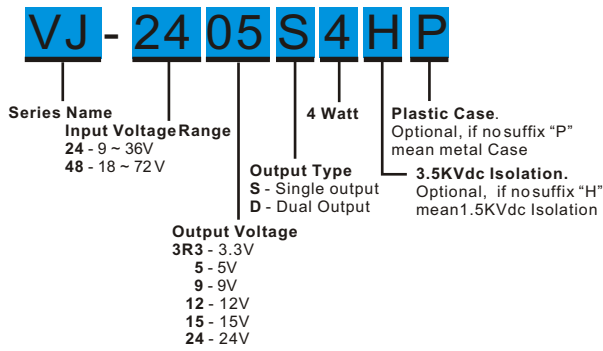

MODEL SELECTION GUIDE

MODEL NUMBER	INPUT Voltage Range (Vdc)	INPUT Current		OUTPUT Voltage (Vdc)	OUTPUT Current		EFFICIENCY @FL(%)	Capacitor Load(uF)
		No-Load (mA)	Full Load (mA)		Min. load (mA)	Full load (mA)		
VJ-243R3S4	9-36	18	222	3.3	0	1200	75	1000
VJ-2405S4	9-36	18	210.9	5	0	800	79	680
VJ-2409S4	9-36	18	208.3	9	0	444	80	100
VJ-2412S4	9-36	18	205.8	12	0	333	81	100
VJ-2415S4	9-36	18	203.3	15	0	266	82	68
VJ-2424S4	9-36	18	208.3	24	0	166	80	47
VJ-243R3D4	9-36	18	222	±3.3	0	±606	75	±470
VJ-2405D4	9-36	18	210.9	±5	0	±400	79	±330
VJ-2409D4	9-36	18	208.3	±9	0	±222	80	±47
VJ-2412D4	9-36	18	205.8	±12	0	±166	81	±47
VJ-2415D4	9-36	18	203.3	±15	0	±133	82	±33
VJ-2424D4	9-36	18	208.3	±24	0	±83	80	±22
VJ-483R3S4	18-72	15	110	3.3	0	1200	75	1000
VJ-4805S4	18-72	15	105.5	5	0	800	79	680
VJ-4809S4	18-72	15	104.2	9	0	444	80	100
VJ-4812S4	18-72	15	102.8	12	0	333	81	100
VJ-4815S4	18-72	15	101.6	15	0	266	82	68
VJ-4824S4	18-72	15	104.2	24	0	166	80	47
VJ-483R3D4	18-72	15	110	±3.3	0	±606	75	±470
VJ-4805D4	18-72	15	105.5	±5	0	±400	79	±330
VJ-4809D4	18-72	15	104.2	±9	0	±222	80	±47
VJ-4812D4	18-72	15	102.8	±12	0	±166	81	±47
VJ-4815D4	18-72	15	101.6	±15	0	±133	82	±33
VJ-4824D4	18-72	15	104.2	±24	0	±83	80	±22

Suffix "H" means 3.5KVdc isolation
 Suffix "P" means Plastic case instead of standard Metal Case

NOTE

1. Ripple/Noise measured with a 1uF ceramic capacitor.
2. Test by nominal input voltage and constant resistor load.
3. Measured Input reflected ripple current with a simulated source inductance of 12uH.
4. Exceeding the absolute ratings of the unit could cause damage. It is not allowed for continuous operating.

TEST CONFIGURATIONS

Input Reflected Ripple Current Test Step

Input reflected ripple current is measured through a source inductor L_{in} (12uH) and a source capacitor C_{in} (47uF, ESR<1.0Ω at 100KHz) at nominal input and full load.

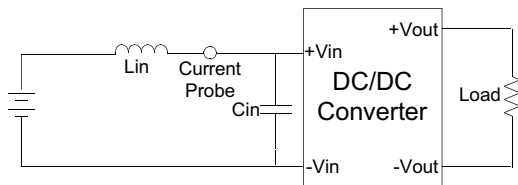

Output Ripple & Noise Measurement Test

Use a capacitor C_{out} (1.0uF) measurement. The Scope measurement bandwidth is 0-20MHz.

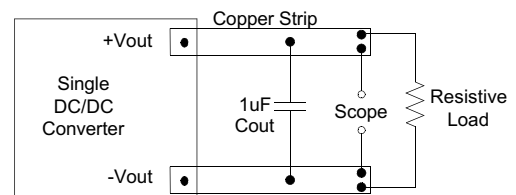

ELECTRICAL CHARACTERISTIC CURVES

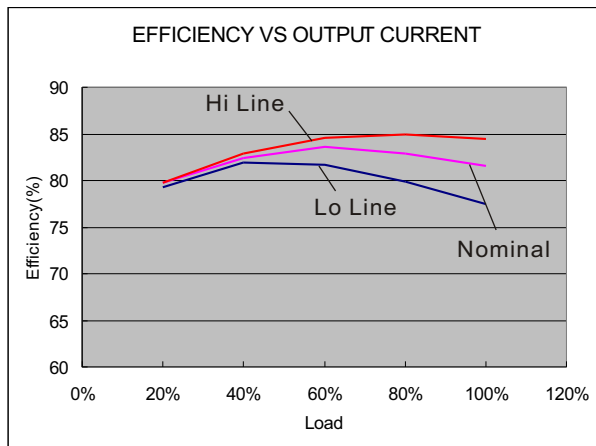

24 Models

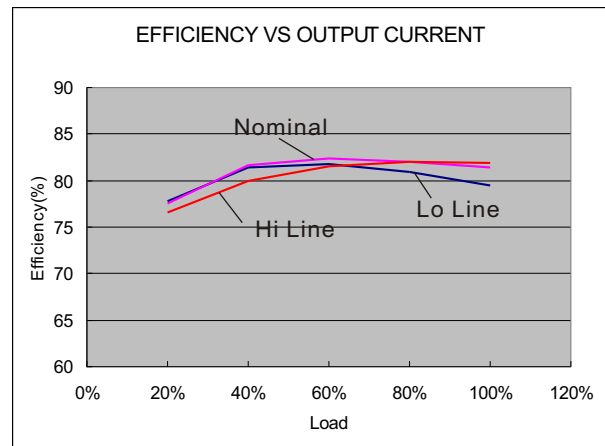

48 Models

MECHANICAL SPECIFICATIONS

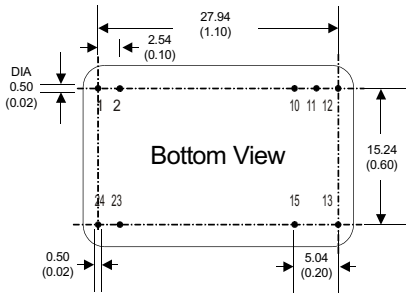
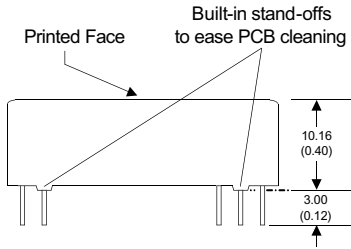
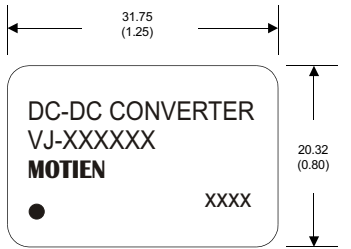

24 Pin DIL Package
Nickel-Coated Copper

- Notes: All dimensions are typical in millimeters (inches).
1. Pin diameter: 0.5 ± 0.05 (0.02 ± 0.002)
 2. Pin pitch and length tolerance: ± 0.35 (± 0.014)
 3. Case Tolerance: ± 0.5 (± 0.02)

PIN CONNECTIONS

PIN NUMBER	SINGLE	DUAL
1	+V Input	+V Input
2	+V Input	+V Input
10	N.C.	Common
11	N.C.	Common
12	-V Output	N.C.
13	+V Output	-V Output
15	N.C.	+V Output
23	-V Input	-V Input
24	-V Input	-V Input

(The Pin Connection of high isolation one is the same with normal one.)

MECHANICAL SPECIFICATIONS

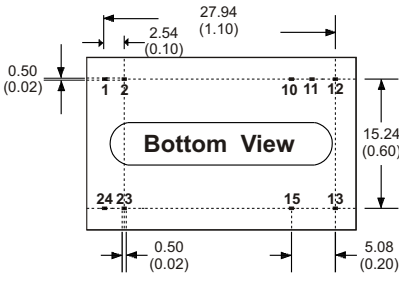
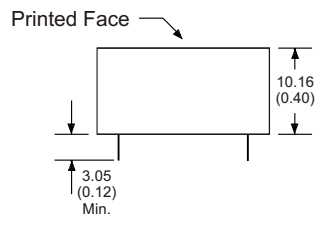
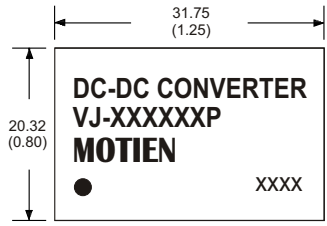

For "P" Case

24 Pin DIL Package
Non-Conductive Plastic

- Notes: All dimensions are typical in millimeters (inches).
1. Pin diameter: 0.5 ± 0.05 (0.02 ± 0.002)
 2. Pin pitch and length tolerance: ± 0.35 (± 0.014)
 3. Case Tolerance: ± 0.5 (± 0.02)
- (The Pin Connection of high isolation one is the same with normal one.)

PIN CONNECTIONS

PIN NUMBER	SINGLE	DUAL
1	+V Input	+V Input
2	+V Input	+V Input
10	N.C.	Common
11	N.C.	Common
12	-V Output	N.C.
13	+V Output	-V Output
15	N.C.	+V Output
23	-V Input	-V Input
24	-V Input	-V Input