

# V5-3W Series

3W Regulated Single & Dual output

## Features

- Regulated 24 Pin DIL Package
- Full SMD Technology
- 1000 VDC Isolation, Up to 6000 VDC(Metal Case Up To 3000Vdc)
- Continuous Short Circuit Protection
- Efficiency up to 83%
- -40 ~ 85°C Operation Temperature Range
- Plastic Case Standard, Optional Metal Case



The V5 series is a family of cost effective 3W single & dual output DC-DC converters. These converters combine miniature package in a 24-pin DIL compatible case with high performance features such as 1000 VDC~6000 VDC input/output isolation voltage, continuous short circuit protection with automatic restart and high line / load regulation. Devices are encapsulated using flame retardant resin. Input voltages of 5, 12, 24 with output voltage of 3.3, 5, 7.2, 9, 12, 15, 24,  $\pm 3.3$ ,  $\pm 5$ ,  $\pm 7.2$ ,  $\pm 9$ ,  $\pm 12$ ,  $\pm 15$  and  $\pm 24$  Vdc. High performance features include high efficiency operation up to 83% and output voltage accuracy of  $\pm 2\%$  maximum. Standard features include an input range of  $\pm 10\%$  tolerance and low output noise and ripple.

All specifications typical at  $T_a=25^\circ\text{C}$ , nominal input voltage and full load unless otherwise specified

OUTPUT SPECIFICATIONS	
Voltage accuracy	$\pm 2\%$
Line regulation	Single & Dual : $\pm 0.5\%$ , max.
Load regulation	Single ( 0% to 100% ) : $\pm 1.0\%$ , max. Dual ( 0% to 100% ) : $\pm 0.5\%$ , max(balanced load) Single & Dual (Output 3.3V Model) : $\pm 2.0\%$ , max.
Ripple & noise (20 MHz bandwidth)(1)	75mV pk-pk, max.
Short Circuit Protection	Indefinite(Automatic Recovery)
Temperature coefficient	$\pm 0.02\%/^\circ\text{C}$
Capacitor load(2)	See table
Transient Recovery Time(3)	250us, typ.
Transient Response Deviation(3)	$\pm 3\%$ , max. (3.3V Output $\pm 5\%$ , max.)

INPUT SPECIFICATIONS	
Voltage Range	$\pm 10\%$
Max. Input Current	See table
No-Load Input Current	See table
Input Filter	PI type
Input Reflected Ripple Current(4)	35mA pk-pk

GENERAL SPECIFICATIONS	
Efficiency	See table
I/O Isolation Voltage(60 sec)	Input/Output 1000~6000Vdc Metal Case/Input&Ouput 1000Vdc
I/O Isolation Capacitance	60 pF Typ.
I/O Isolation Resistance	1000M Ohm
Switching Frequency	Single 40kHz typ Dual 250kHz typ
Humidity	95% rel H
Reliability Calculated MTBF(MIL-HDBK-217 F)	>1 Mhrs
Safety Standard : ( designed to meet )	IEC 60950-1

PHYSICAL SPECIFICATIONS	
Case Material	Non-conductive Black Plastic(UL94V-0 rated) Nickel-coated Copper
Base Material	Non-conductive Black Plastic(UL94V-0 rated)
Pin Material	0.5mm Alloy42 Solder-coated $\Phi 0.5\text{mm}$ Brass Solder-coated
Potting Material	Epoxy (UL94V-0 rated)
Weight	12.5g(Plastic Case)/15.0g(Meta Case)
Dimensions	1.25"x0.8"x0.4"

ENVIRONMENT SPECIFICATIONS	
Operating Temperature	$-40^\circ\text{C} \sim 85^\circ\text{C}$ (See Derating Curve)
Maximum Case Temperature	100°C
Storage Temperature	$-40^\circ\text{C} \sim 125^\circ\text{C}$
Cooling	Nature Convection

ABSOLUTE MAXIMUM RATINGS(5)	
These are stress ratings. Exposure of devices to any of these conditions may adversely affect long-term reliability.	
Input Surge Voltage(100mS)	
5 Models	7 Vdc , max.
12 Models	15 Vdc , max.
24 Models	28 Vdc , max.
Soldering Temperature (1.5mm from case 10 sec. max.)	260°C , max.

EMC SPECIFICATIONS		
Radiated Emissions	EN55022	CLASS A
Conducted Emissions (7)	EN55022	CLASS A
ESD	IEC 61000-4-2	Perf. Criteria A
RS	IEC 61000-4-3	Perf. Criteria A
EFT (8)	IEC 61000-4-4	Perf. Criteria A
Surge (8)	IEC 61000-4-5	Perf. Criteria A
CS	IEC 61000-4-6	Perf. Criteria A
PFMF	IEC 61000-4-8	Perf. Criteria A

## V5 - 3W Regulated Single & Dual output

### PART NUMBER STRUCTURE

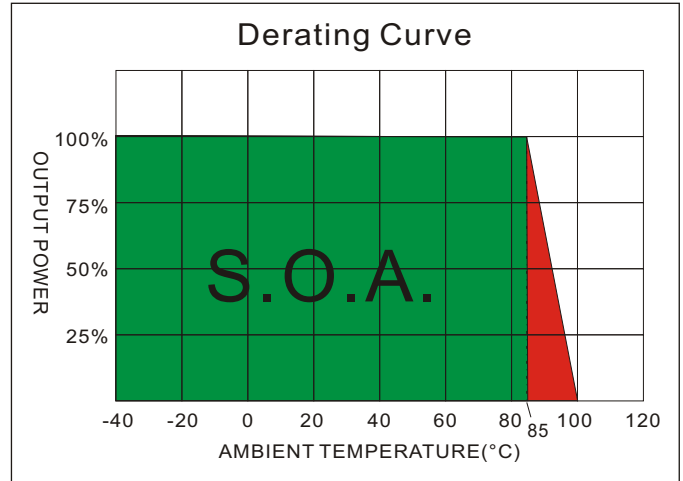
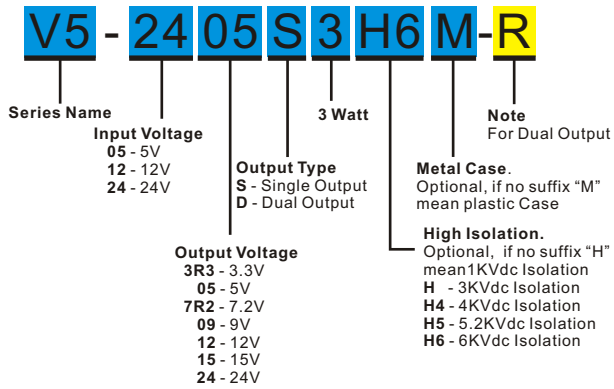

## MODEL SELECTION GUIDE

MODEL NUMBER	INPUT	INPUT Current		OUTPUT	OUTPUT Current	EFFICIENCY @FL(%)	Capacitor Load(uF)
	Voltage Range (Vdc)	No-Load (mA)	Full Load (mA)	Voltage (Vdc)	Full load (mA)		
V5-053R3S3	5	62	683	3.3	600	58	470
V5-0505S3	5	65	909	5	600	66	470
V5-057R2S3	5	65	923	7.2	417	65	470
V5-0509S3	5	70	882	9	333	68	470
V5-0512S3	5	60	845	12	250	71	470
V5-0515S3	5	70	833	15	200	72	470
V5-0518S3	5	70	857	18	167	70	470
V5-0524S3	5	100	896	24	125	67	470
V5-123R3S3	12	30	232	3.3	600	71	470
V5-1205S3	12	36	253	5	600	66	470
V5-127R2S3	12	32	235	7.2	417	71	470
V5-1209S3	12	32	235	9	333	71	470
V5-1212S3	12	37	231	12	250	72	470
V5-1215S3	12	35	225	15	200	74	470
V5-1218S3	12	35	222	18	167	75	470
V5-1224S3	12	55	235	24	125	71	470
V5-243R3S3	24	10	158	3.3	700	61	470
V5-2405S3	24	23	187	5	600	67	470
V5-247R2S3	24	25	189	7.2	417	66	470
V5-2409S3	24	27	184	9	333	68	470
V5-2412S3	24	30	181	12	250	69	470
V5-2415S3	24	28	179	15	200	70	470
V5-2418S3	24	16	169	18	167	74	470
V5-2424S3	24	20	167	24	125	75	470
V5-053R3D3-R	5	15	776	±3.3	±400	68	±1000
V5-0505D3-R	5	20	845	±5	±300	71	±470
V5-057R2D3-R	5	20	811	±7.2	±417	74	±470
V5-0509D3-R	5	25	789	±9	±167	76	±470
V5-0512D3-R	5	40	822	±12	±125	73	±470
V5-0515D3-R	5	30	811	±15	±100	74	±470
V5-0518D3-R	5	45	822	±18	±167	73	±220

Suffix "H" means 3KVdc isolation      Suffix "H4" means 4KVdc isolation      Suffix "H5" means 5.2KVdc isolation  
 Suffix "H6" means 6KVdc isolation  
 Suffix "M" means Metal Case Up To 3KVdc isolation

The models listed above is just for standard type. If you need the special specification product, please contact our service member by telephone presented in shortform cover or e-mail to : sales@motien.com.tw

## V5 - 3W Regulated Single & Dual output

MODEL NUMBER	INPUT	INPUT Current		OUTPUT	OUTPUT Current	EFFICIENCY @FL(%)	Capacitor Load(μF)
	Voltage Range (Vdc)	No-Load (mA)	Full Load (mA)	Voltage (Vdc)	Full load (mA)		
V5-0524D3-R	5	45	800	±24	±62.5	75	±220
V5-123R3D3-R	12	7	306	±3.3	±400	72	±1000
V5-1205D3-R	12	8	321	±5	±300	78	±1000
V5-127R2D3-R	12	8	313	±7.2	±417	80	±470
V5-1209D3-R	12	10	313	±9	±167	80	±470
V5-1212D3-R	12	10	321	±12	±125	78	±470
V5-1215D3-R	12	15	309	±15	±100	81	±470
V5-1218D3-R	12	15	309	±18	±167	81	±220
V5-1224D3-R	12	20	316	±24	±62.5	79	±220
V5-243R3D3-R	24	5	174	±3.3	±455	72	±1000
V5-2405D3-R	24	6	158	±5	±300	79	±470
V5-247R2D3-R	24	5	158	±7.2	±417	79	±470
V5-2409D3-R	24	7	152	±9	±167	82	±470
V5-2412D3-R	24	8	151	±12	±125	83	±470
V5-2415D3-R	24	10	154	±15	±100	81	±470
V5-2418D3-R	24	15	156	±18	±167	80	±220
V5-2424D3-R	24	15	154	±24	±62.5	81	±220

Suffix "H" means 3KVdc isolation      Suffix "H4" means 4KVdc isolation      Suffix "H5" means 5.2KVdc isolation  
 Suffix "H6" means 6KVdc isolation  
 Suffix "M" means Metal Case Up To 3KVdc isolation

### TEST CONFIGURATIONS

#### EMI Filter

Input filter components (C1,C2, L) are used to help meet conducted emissions requirement for the module. These components should be mounted as close as possible to the module; and all leads should be minimized to decrease radiated noise.

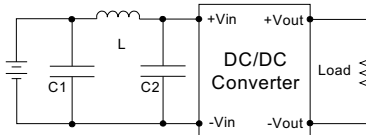

	C1	L	C2
V5-05XXXXX	220μF/100V	12μH	220μF/100V
V5-12XXXXX	220μF/100V	12μH	220μF/100V
V5-24XXXXX	220μF/100V	12μH	220μF/100V

Single Output

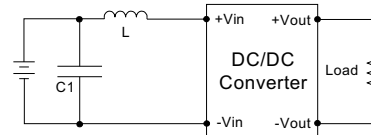

	C1	L
V5-05XXXXX	220μF/100V	12μH
V5-12XXXXX	220μF/100V	12μH
V5-24XXXXX	220μF/100V	12μH

Dual Output

### NOTE

1. Ripple/Noise measured with 20MHz bandwidth.
2. Tested by minimal Vin and constant resistive load.
3. Tested by normal Vin and 25% load step change ( 75%-50%-25% of Io )
4. Measured Input reflected ripple current with a simulated source inductance of 12μH.
5. Exceeding the absolute ratings of the unit could cause damage. It is not allowed for continuous operating.
6. Operation under no-load conditions will not damage these devices, however they may not meet all listed specifications.
7. Input filter components are required to help meet conducted emission class A, which application refer to the EMI Filter of design & feature configuration.
8. An external filter capacitor is required if the module has to meet IEC61000-4-4 and IEC61000-4-5.  
The filter capacitor Motien suggest: Nippon - chemi - con KY series, 220μF/100V.

The models listed above is just for standard type. If you need the special specification product, please contact our service member by telephone presented in shortform cover or e-mail to : sales@motien.com.tw

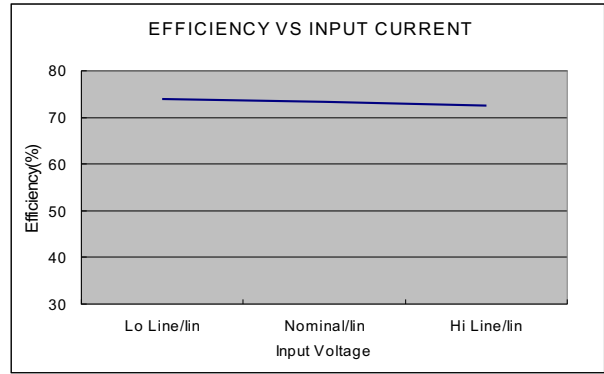
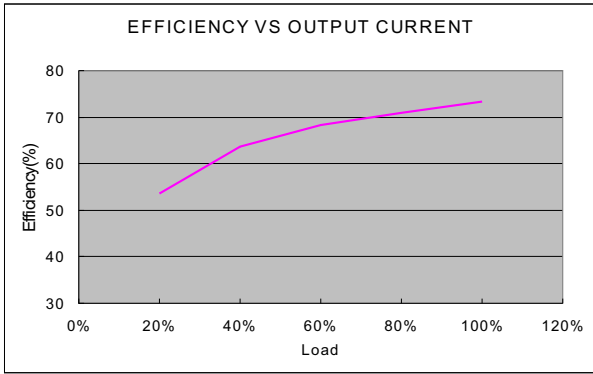

05 Single Output Models

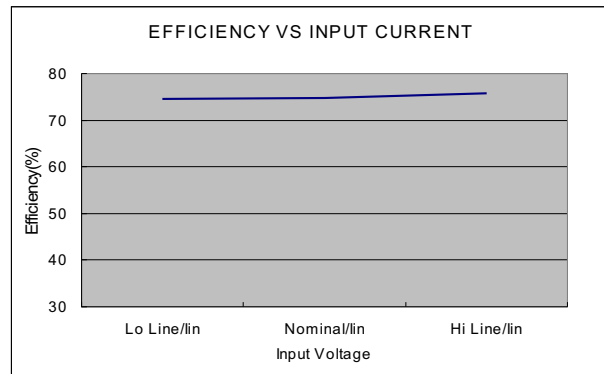
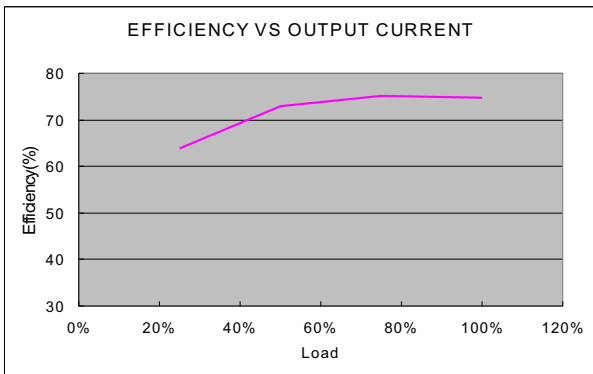

05 Dual Output Models

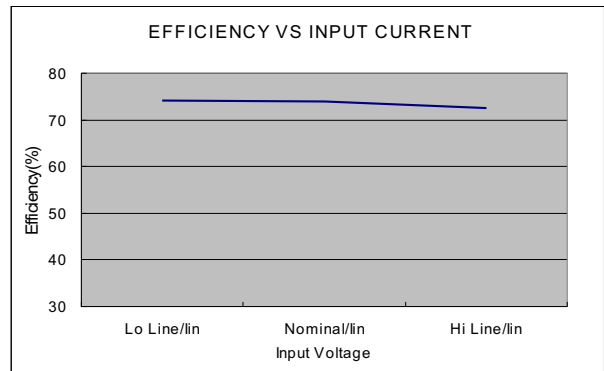
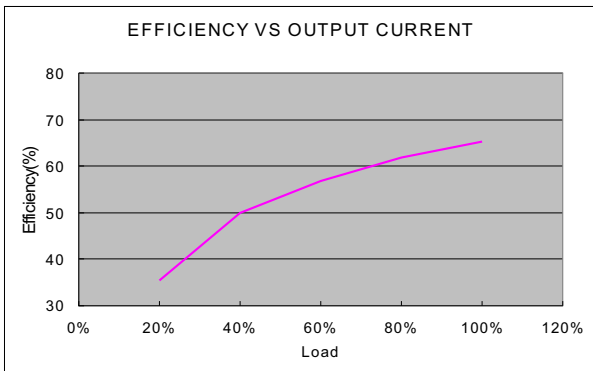

24 Single Output Models

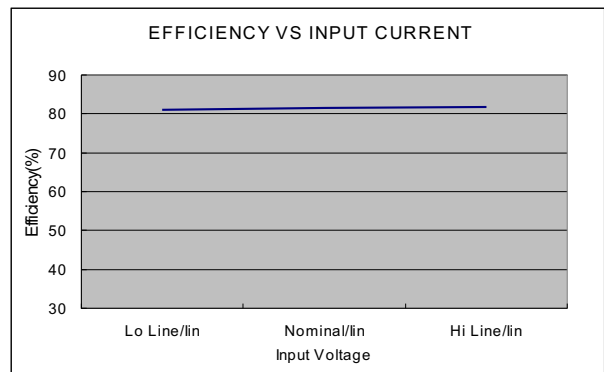
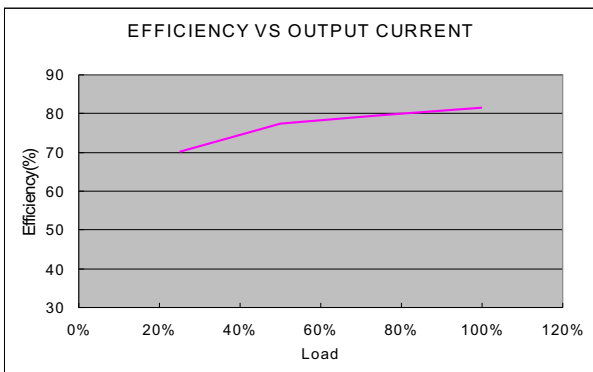

24 Dual Output Models

**MECHANICAL SPECIFICATIONS**

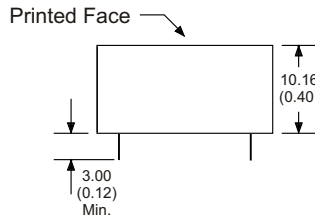
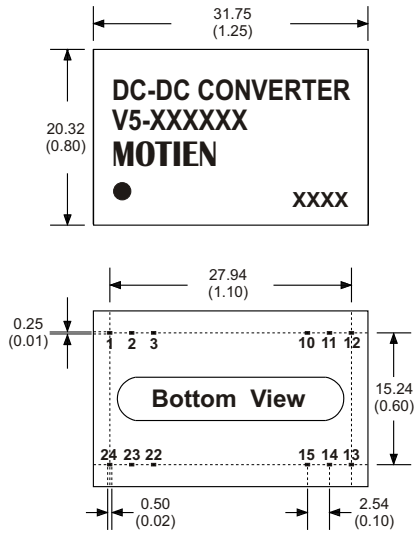

**24 Pin DIL Package  
Non-Conductive Plastic**

Notes: All dimensions are typical in millimeters ( inches ).  
 1. Pin diameter:  $0.5 \pm 0.05$  (  $0.02 \pm 0.002$  )  
 2. Pin pitch and length tolerance:  $\pm 0.35$  (  $\pm 0.014$  )  
 3. Case Tolerance:  $\pm 0.5$  (  $\pm 0.02$  )

PIN CONNECTIONS				
PIN NUMBER	SINGLE	DUAL	SINGLE-H	DUAL-H
1	+V Input	+V Input	+V Input	+V Input
2	N.C.	-V Output	+V Input	+V Input
3	N.C.	Common	N.P.	N.P.
10	-V Output	Common	N.P.	Common
11	+V Output	+V Output	N.P.	Common
12	-V Input	-V Input	-V Output	N.P.
13	-V Input	-V Input	+V Output	-V Output
14	+V Output	+V Output	N.P.	N.P.
15	-V Output	Common	N.P.	+V Output
22	N.C.	Common	N.P.	N.P.
23	N.C.	-V Output	-V Input	-V Input
24	+V Input	+V Input	-V Input	-V Input

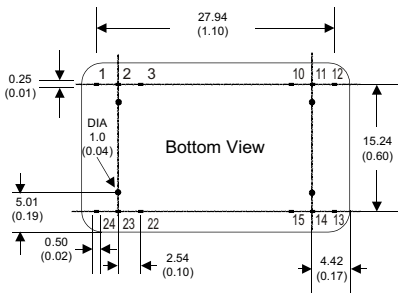
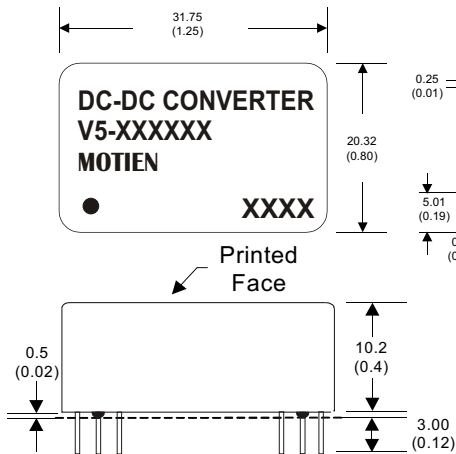

**24 Pin DIL Package  
Nickel-Coated Copper**

For "M" Case

Notes: All dimensions are typical in millimeters ( inches ).  
 1. Pin diameter:  $0.5 \pm 0.05$  (  $0.02 \pm 0.002$  )  
 2. Pin pitch and length tolerance:  $\pm 0.35$  (  $\pm 0.014$  )  
 3. Case Tolerance:  $\pm 0.5$  (  $\pm 0.02$  )  
 4. Stand-off tolerance:  $\pm 0.1$  (  $\pm 0.004$  )

PIN CONNECTIONS				
PIN NUMBER	SINGLE	DUAL	SINGLE-H	DUAL-H
1	+V Input	+V Input	+V Input	+V Input
2	N.C.	-V Output	+V Input	+V Input
3	N.C.	Common	N.P.	N.P.
10	-V Output	Common	N.P.	Common
11	+V Output	+V Output	N.P.	Common
12	-V Input	-V Input	-V Output	N.P.
13	-V Input	-V Input	+V Output	-V Output
14	+V Output	+V Output	N.P.	N.P.
15	-V Output	Common	N.P.	+V Output
22	N.C.	Common	N.P.	N.P.
23	N.C.	-V Output	-V Input	-V Input
24	+V Input	+V Input	-V Input	-V Input