

M1 Series

2W Semi-regulated Single & Dual output

Features

- 7 Pin SIL Package
- Semi-regulated output
- 1000 VDC Isolation
- Up to 3000 VDC Isolation
- Low Ripple and Noise
- Efficiency up to 89%
- -40 ~ 85°C Operation Temperature Range
- Non-Conductive Black Plastic Case

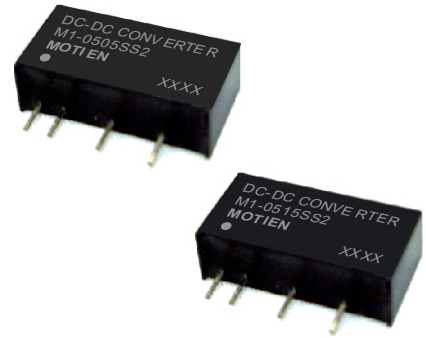

The M1 series is a family of cost effective 2W single & dual output DC-DC converters. These converters achieve low cost, high efficiency, semi-regulated and ultra-miniature SIP 7 pin size. Devices are encapsulated using flame retardant resin. The models operate from input voltage of 5, 12, 15, 24Vdc with output voltage of 5, 9, 12, 15, ±5, ±9, ±12, ±15 Vdc. High efficiency operation and output voltage accuracy of +2%~-4% maximum. Standard features include an input range of ±10% tolerance and low output noise and ripple.

All specifications typical at Ta=25°C, nominal input voltage and full load unless otherwise specified

OUTPUT SPECIFICATIONS	
Voltage accuracy	+2~-4%
Line regulation	±1.2% / Per 1% Vin Change
Load regulation(From 10% to 100% Load)	See table
Ripple & noise (20 MHz bandwidth)(1)	50mV pk-pk
Temperature coefficient	±0.02%/°C
Capacitor load(2)	See table

INPUT SPECIFICATIONS	
Voltage Range	±10%
Max. Input Current	See table
No-Load Input Current	See table
Input Filter	Capacitors
Input Reflected Ripple Current	5V 25mA pk-pk
	12V 25mA pk-pk
	15V 30mA pk-pk
	24V 40mA pk-pk

GENERAL SPECIFICATIONS	
Efficiency	See table
I/O Isolation Voltage(60 sec)	1000~3000Vdc
Input/Output	60 pF Typ.
I/O Isolation Capacitance	1G Ohm
I/O Isolation Resistance	Variable 70kHz
Switching Frequency	95% rel H
Humidity	>1.9 Mhrs
Reliability Calculated MTBF(MIL-HDBK-217 F)	IEC 60950-1
Safety Standard : (designed to meet)	

EMC SPECIFICATIONS		
Radiated Emissions	EN55022	CLASS B
Conducted Emissions (3)	EN55022	CLASS B
ESD	IEC 61000-4-2	Perf. Criteria A
RS	IEC 61000-4-3	Perf. Criteria A
EFT(4)	IEC 61000-4-4	Perf. Criteria A
CS	IEC 61000-4-6	Perf. Criteria A
PFMF	IEC 61000-4-8	Perf. Criteria A

PHYSICAL SPECIFICATIONS	
Case Material	Non-conductive Black Plastic(UL94V-0 rated)
Pin Material	C5191R-H Solder-coated
Potting Material	Epoxy (UL94V-0 rated)
Weight	2.8g, Typ.
Dimensions	SIP Case 0.76"x0.28"x0.39"

ENVIRONMENT SPECIFICATIONS	
Operating Temperature	-40°C~85°C(See Derating Curve)
Maximum Case Temperature	100°C
Storage Temperature	-40°C~125°C
Cooling	Nature Convection

ABSOLUTE MAXIMUM RATINGS(5)	
These are stress ratings. Exposure of devices to any of these conditions may adversely affect long-term reliability.	
Input Surge Voltage(100mS)	
5 Models	9 Vdc, max.
12 Models	18 Vdc, max.
15 Models	20 Vdc, max.
24 Models	30 Vdc, max.
Soldering Temperature	260°C
(1.5mm from case 10 sec.)	

M1 - 2W Semi-regulated Single & Dual output

PART NUMBER STRUCTURE

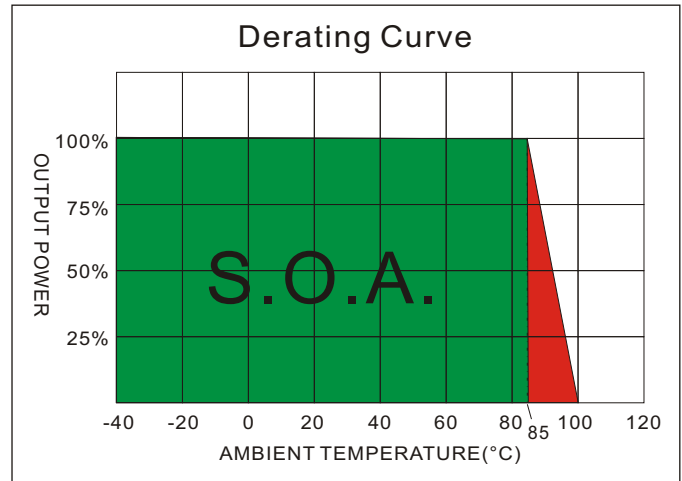
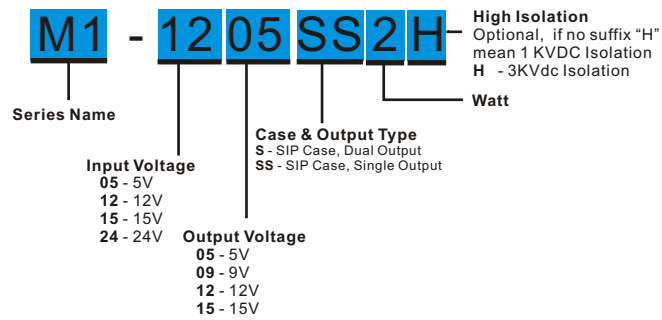

MODEL SELECTION GUIDE

MODEL NUMBER	INPUT Voltage Range (Vdc)	INPUT Current		OUTPUT Voltage (Vdc)	OUTPUT Current Full load (mA)	LOAD Regulation %	EFFICIENCY @FL(%)	Capacitor Load(μF)
		No-Load (mA)	Full Load (mA)					
M1-0505S2	5	50	488	±5	±200	5	82	±100
M1-0509S2	5	50	471	±9	±111.1	3.9	85	±100
M1-0512S2	5	50	465	±12	±83.3	3.7	86	±47
M1-0515S2	5	50	460	±15	±66.6	4	87	±47
M1-1205S2	12	40	200	±5	±200	3.4	84	±100
M1-1209S2	12	40	189	±9	±111.1	2.4	88	±100
M1-1212S2	12	40	187	±12	±83.3	2.2	89	±47
M1-1215S2	12	40	187	±15	±66.6	1.9	89	±47
M1-1505S2	15	30	157	±5	±200	3.4	85	±100
M1-1509S2	15	30	152	±9	±111.1	2.4	88	±100
M1-1512S2	15	30	152	±12	±83.3	2.2	88	±47
M1-1515S2	15	30	152	±15	±66.6	1.9	88	±47
M1-2405S2	24	20	102	±5	±200	3.5	82	±100
M1-2409S2	24	20	98	±9	±111.1	2.4	85	±100
M1-2412S2	24	20	97	±12	±83.3	2.2	86	±47
M1-2415S2	24	20	96	±15	±66.6	1.9	87	±47
M1-0505SS2	5	50	494	5	400	6	81	220
M1-0509SS2	5	50	471	9	222.2	4.2	85	220
M1-0512SS2	5	50	471	12	166.6	3.8	85	100
M1-0515SS2	5	50	465	15	133.3	4.5	86	100
M1-1205SS2	12	40	198	5	400	4.2	84	220
M1-1209SS2	12	40	194	9	222.2	2.8	86	220
M1-1212SS2	12	40	189	12	166.6	2.4	88	100
M1-1215SS2	12	40	189	15	133.3	2.2	88	100
M1-1505SS2	15	30	157	5	400	4	85	220
M1-1509SS2	15	30	153	9	222.2	2.6	87	220
M1-1512SS2	15	30	153	12	166.6	2.4	87	100
M1-1515SS2	15	30	152	15	133.3	2	88	100
M1-2405SS2	24	20	102	5	400	4.5	82	220
M1-2409SS2	24	20	99	9	222.2	3.5	84	220
M1-2412SS2	24	20	97	12	166.6	3	86	100
M1-2415SS2	24	20	96	15	133.3	2.8	87	100

Suffix "H" means 3 K Vdc isolation

NOTE

- Ripple/Noise measured with 20MHz bandwidth and 1.0uF ceramic capacitor.
- Tested by minimal Vin and constant resistive full load.
- Input filter components (C1, L, C2, C3) are used to help meet conducted emissions requirement for the module. These components should be mounted as close as possible to the module; and all leads should be minimized to decrease radiated noise.
- An external filter capacitor is required if the module has to meet IEC61000-4-4. The filter capacitor Motien suggest: Nippon chemi-con KY series, 220uF/100V.
- Exceeding the absolute ratings of the unit could cause damage. It is not allowed for continuous operating.
- Operation under no-load conditions will not damage these devices, however they may not meet all listed specifications.

The models listed above is just for standard type. If you need the special specification product, please contact our service member by telephone presented in shortform cover or e-mail to : sales@motien.com.tw

TEST CONFIGURATIONS

Output Ripple & Noise Measurement Test

Use a capacitor Cout(1.0uF) measurement.
The Scope measurement bandwidth is 0-20MHz.

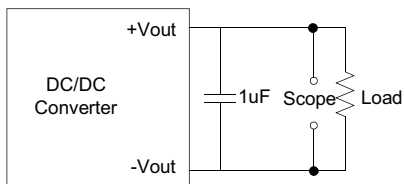

EMI Filter

Input filter components (C1,L,C2,C3) are used to help meet conducted emissions requirement for the module. These components should be mounted as close as possible to the module; and all leads should be minimized to decrease radiated noise.

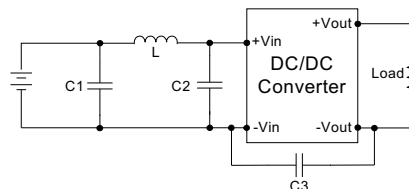

	C1	L	C2	C3
M1-05XXXXX	1210, 2.2uF/100V	18uH		
M1-12XXXXX	1210, 2.2uF/100V	18uH		
M1-15XXXXX	1210, 2.2uF/100V	18uH		
M1-24XXXXX	1210, 2.2uF/100V	18uH	1210, 2.2uF/100V	1206, 470pF/2KV

ELECTRICAL CHARACTERISTIC CURVES

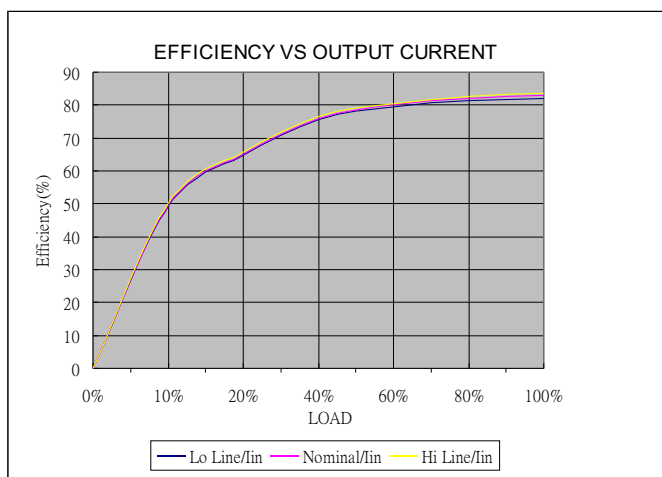

M1-0505SS2

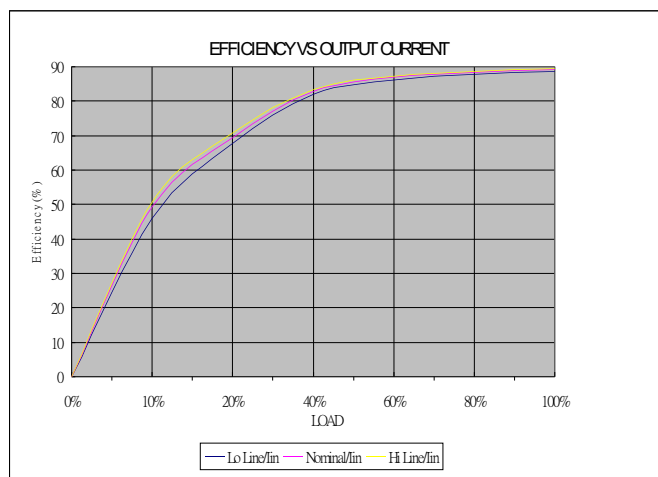

M1-0515S2

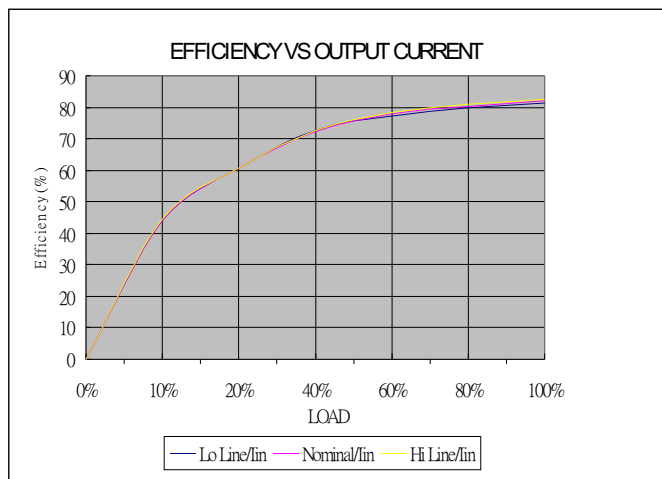

M1-2405SS2

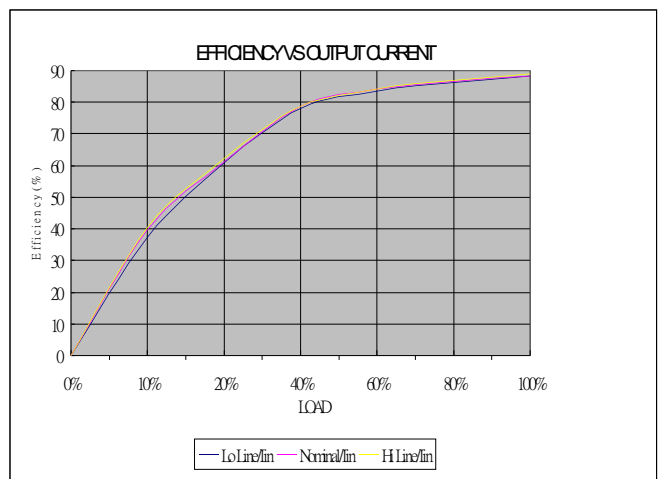

M1-2415S2

The models listed above is just for standard type. If you need the special specification product, please contact our service member by telephone presented in shortform cover or e-mail to : sales@motien.com.tw

MECHANICAL SPECIFICATIONS

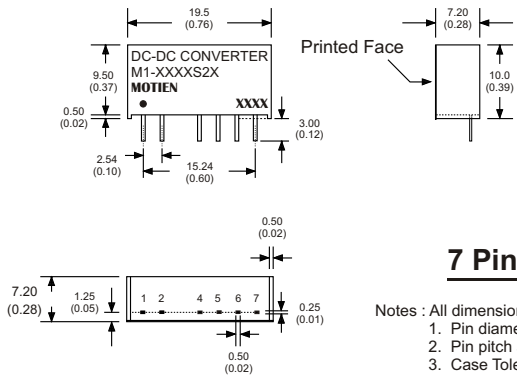

7 Pin SIL Package

Notes : All dimensions are typical in millimeters (inches).
 1. Pin diameter: 0.5±0.05 (0.02±0.002)
 2. Pin pitch and length tolerance: ±0.35 (±0.014)
 3. Case Tolerance: ±0.5 (±0.02)

PIN CONNECTIONS

PIN NUMBER	SINGLE	DUAL	SINGLE-H	DUAL-H
1	+V Input	+V Input	+V Input	+V Input
2	-V Input	-V Input	-V Input	-V Input
4	-V Output	-V Output	N.P.	N.P.
5	N.P.	Common	-V Output	-V Output
6	+V Output	+V Output	N.P.	Common
7	N.P.	N.P.	+V Output	+V Output