

# VF-2W Series

2W Regulated Single output



## Features

- 12 Pin SIL Package
- 1000 VDC Isolation
- Up to 5200 VDC Isolation
- Continuous Short Circuit Protection
- Efficiency up to 72%
- -25 ~ 71°C Operation Temperature Range



The VF series is a family of cost effective 2W single output DC-DC converters. These converters combine miniature package in a 12-pin SIL compatible case with high performance features such as 1000 VDC~5200 VDC input/output isolation voltage, continuous short circuit protection with automatic restart and high line / load regulation. Devices are encapsulated using flame retardant resin. Input voltages of 5, 12, 24 with output voltage of 3.3, 5, 7.2, 9, 12, 15, 18, 24 Vdc. High performance features include high efficiency operation up to 72% and output voltage accuracy of  $\pm 2\%$  maximum. Standard features include an input range of  $\pm 10\%$  tolerance and low output noise and ripple.

All specifications typical at  $T_a=25^\circ\text{C}$ , nominal input voltage and full load unless otherwise specified

OUTPUT SPECIFICATIONS	
Voltage accuracy	$\pm 2\%$
Line regulation	$\pm 0.5\%$
Load regulation	(From 0% to 100% Load) $\pm 0.5\%$ (Output 3.3V Model) $\pm 1.5\%$
Ripple & noise (20 MHz bandwidth)(1)	75mV pk-pk
Short Circuit Protection	Indefinite(Automatic Recovery)
Temperature coefficient	$\pm 0.02\%/^\circ\text{C}$
Capacitor load(2)	See table

INPUT SPECIFICATIONS	
Voltage Range	$\pm 10\%$
Max. Input Current	See table
No-Load Input Current	See table
Input Filter	Capacitor
Input Reflected Ripple Current(3)	20mA pk-pk

GENERAL SPECIFICATIONS	
Efficiency	See table
I/O Isolation Voltage(60 sec)	1000~5200Vdc
Input/Output	1000~5200Vdc
I/O Isolation Capacitance	60 pF Typ.
I/O Isolation Resistance	1000M Ohm
Switching Frequency	50kHz typ
Humidity	95% rel H
Reliability Calculated MTBF(MIL-HDBK-217 F)	>1.12 Mhrs
Safety Standard : (designed to meet)	IEC 60950-1

PHYSICAL SPECIFICATIONS	
Case Material	Non-conductive Black Plastic(UL94V-0 rated)
Pin Material	0.5mm Alloy42 Solder-coated
Potting Material	Epoxy (UL94V-0 rated)
Weight	7.2g
Dimensions	1.26"x0.32"x0.57"

ENVIRONMENT SPECIFICATIONS	
Operating Temperature	$-25^\circ\text{C} \sim 71^\circ\text{C}$ (See Derating Curve)
Maximum Case Temperature	100°C
Storage Temperature	$-40^\circ\text{C} \sim 125^\circ\text{C}$
Cooling	Nature Convection

ABSOLUTE MAXIMUM RATINGS(4)	
These are stress ratings. Exposure of devices to any of these conditions may adversely affect long-term reliability.	
Input Surge Voltage(100mS)	
5 Models	7 Vdc ,max.
12 Models	15 Vdc ,max.
24 Models	28 Vdc ,max.
Soldering Temperature	260°C ,max.
(1.5mm from case 10 sec. max.)	

EMC SPECIFICATIONS		
Radiated Emissions	EN55022	CLASS B
Conducted Emissions (6)	EN55022	CLASS B
ESD	IEC 61000-4-2	Perf. Criteria A
RS	IEC 61000-4-3	Perf. Criteria A
EFT (7)	IEC 61000-4-4	Perf. Criteria A
Surge (7)	IEC 61000-4-5	Perf. Criteria A
CS	IEC 61000-4-6	Perf. Criteria A
PFMF	IEC 61000-4-8	Perf. Criteria A

The information and specifications contained in this data sheet are believed to be correct at time of publication. However, MOTIEN Technologies accepts no responsibility for consequences arising from printing errors or inaccuracies. Specifications are subject to change without notice. No rights under any patent accompany the sale of any such product(s) or information contained herein.

## VF - 2W Regulated Single output

### PART NUMBER STRUCTURE

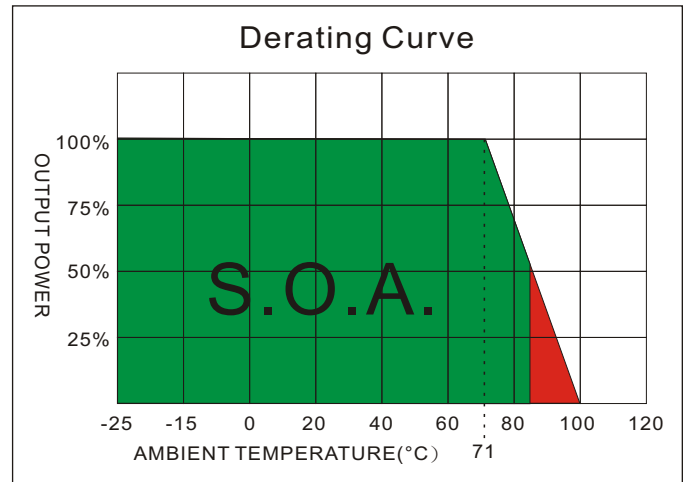
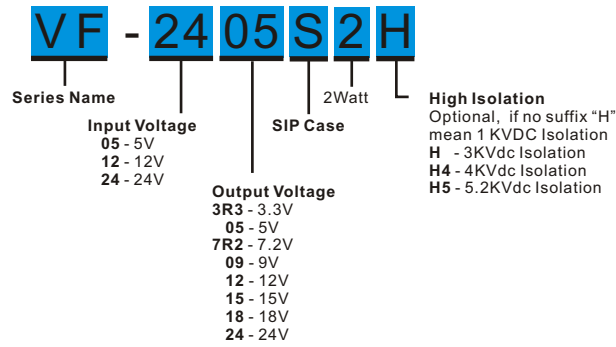

## MODEL SELECTION GUIDE

MODEL NUMBER	INPUT	INPUT Current		OUTPUT	OUTPUT Current	EFFICIENCY @FL(%)	Capacitor Load(uF)
	Voltage Range (Vdc)	No-Load (mA)	Full Load (mA)	Voltage (Vdc)	Full load (mA)		
VF-053R3S2	5	68	559	3.3	500	59	330
VF-0505S2	5	45	588	5	400	68	330
VF-057R2S2	5	90	625	7.2	277.7	64	330
VF-0509S2	5	75	563	9	222.2	71	330
VF-0512S2	5	80	597	12	166.6	67	330
VF-0515S2	5	95	571	15	133.3	70	330
VF-0518S2	5	95	580	18	111.1	69	330
VF-0524S2	5	76	597	24	83.3	67	330
VF-123R3S2	12	30	250	3.3	500	55	330
VF-1205S2	12	20	249	5	400	67	330
VF-127R2S2	12	30	253	7.2	277.7	66	330
VF-1209S2	12	45	253	9	222.2	66	330
VF-1212S2	12	45	249	12	166.6	67	330
VF-1215S2	12	45	245	15	133.3	68	330
VF-1218S2	12	50	256	18	111.1	65	330
VF-1224S2	12	35	231	24	83.3	72	330
VF-243R3S2	24	25	127	3.3	500	54	330
VF-2405S2	24	25	132	5	400	63	330
VF-247R2S2	24	22	123	7.2	277.7	68	330
VF-2409S2	24	20	117	9	222.2	71	330
VF-2412S2	24	20	119	12	166.6	70	330
VF-2415S2	24	25	124	15	133.3	67	330
VF-2418S2	24	20	117	18	111.1	71	330
VF-2424S2	24	20	116	24	83.3	72	330

Suffix "H" means 3 KVdc isolation

Suffix "H4" means 4 KVdc isolation

Suffix "H5" means 5.2 KVdc isolation

**TEST CONFIGURATIONS**

**Input Reflected Ripple Current Test Step**

Input reflected ripple current is measured through a source inductor  $L_{in}$ (12uH) and a source capacitor  $C_{in}$ (47uF, ESR<1.0Ω at 100KHz) at nominal input and full load.

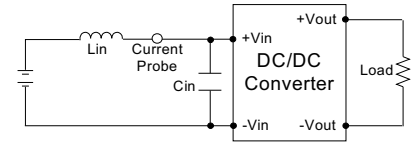

**Output Ripple & Noise Measurement Test**

The Scope measurement bandwidth is 20MHz .

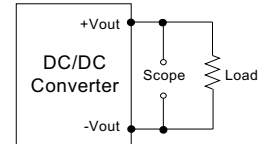

**EMI Filter**

Input filter components (C1, L ) are used to help meet conducted emissions requirement for the module. These components should be mounted as close as possible to the module; and all leads should be minimized to decrease radiated noise.

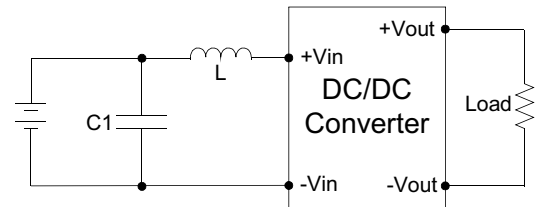

	C1	L
VF-05XXXXXX	220uF/100V	12uH
VF-12XXXXXX	220uF/100V	12uH
VF-24XXXXXX	220uF/100V	12uH

**NOTE**

1. Ripple/Noise measured with 20MHz bandwidth.
2. Tested by minimal  $V_{in}$  and constant resistive load.
3. Measured Input reflected ripple current with a simulated source inductance of 12uH.
4. Exceeding the absolute ratings of the unit could cause damage. It is not allowed for continuous operating.
5. Operation under no-load conditions will not damage these devices, however they may not meet all listed specifications.
6. Input filter components are be required to help meet conducted emission class B, which application refer to the EMI Filter of design & feature configuration.
7. An external filter capacitor is required if the module has to meet IEC61000-4-4 and IEC61000-4-5. The filter capacitor Motien suggest: Nippon - chemi - con KY series, 470uF/100V.

# VF - 2W Regulated Single output

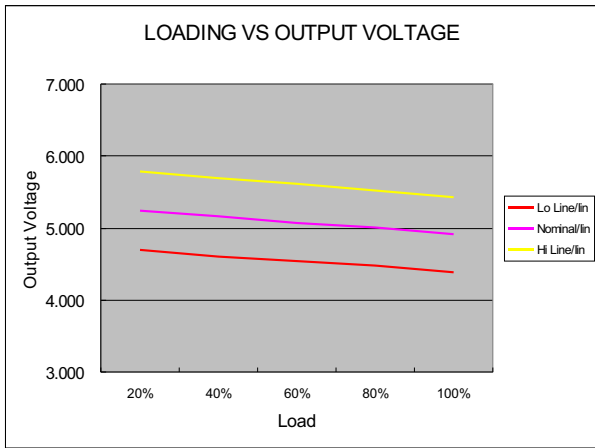

05 Models

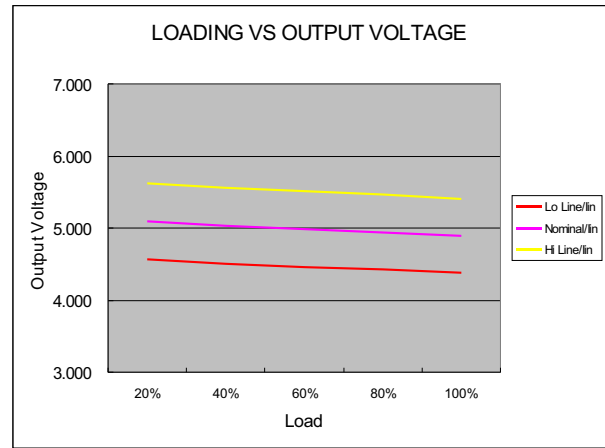

12 Models

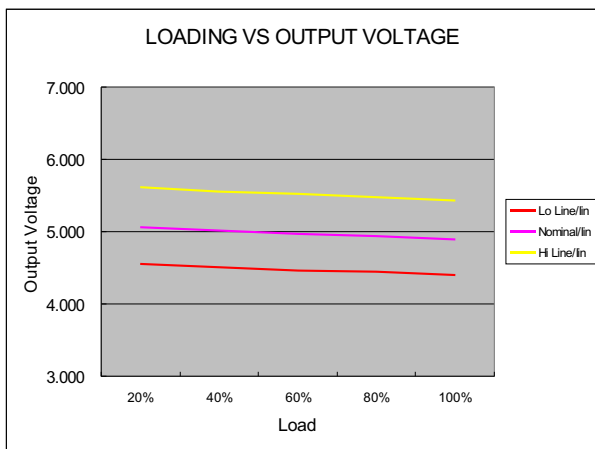

24 Models

## MECHANICAL SPECIFICATIONS

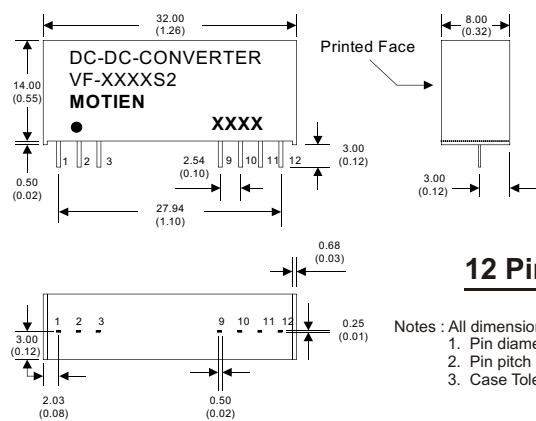

PIN CONNECTIONS		
PIN NUMBER	SINGLE	SINGLE-H
1	+V Input	+V Input
2	N.C.	-V Input
3	N.C.	N.C.
9	N.C.	N.C.
10	-V Output	-V Output
11	+V Output	+V Output
12	-V Input	N.C.