

### PRODUCT OVERVIEW



Rarely has a Series of low-power DC/DC converters been designed with low cost and DATEL's made in the USA quality and reliability. Our new UST Series of single-output DC/DC's achieves this cost-savings and reliability by implementing a proven circuit architecture (170-200kHz flyback design) as a full, SMT-on-pcb assembly (including surface-mount magnetics) that is truly 100% automatically assembled. Packaged in miniature 1.25" x 0.8", DIP-like plastic packages (UL94V-0 rated) and requiring no external components, UST Series DC/DC's bring true component-like convenience to designers of today's distributed power systems.

Output voltages are 5, 12 or 15 Volts. Input voltage ranges are 4.5-9V ("D5" models), 9-18V ("D12" models) or an ultra-wide 18-72V ("D48" models). UST DC/DC's are fully isolated (1000Vdc guaranteed) and include input (pi type) and output filters within their package. Output transient

response is a quick 200µsec, while output ripple and noise are typically 75mVp-p.

These rugged modules are fully encapsulated with a thermally conductive potting compound that contributes to their outstanding moisture/vibration resistance and impressive MTBF. They operate over the full -40 to +75°C temperature range without derating. All models have been thoroughly characterized (electrically, mechanically and thermally), qualified (including HALT), and EMI/EMC tested. Additionally, they are certified to UL1950, CSA 22.2 No. 950 and IEC950.

DATEL's UST Model 3W DC/DC's are excellent selections for telecom/datacom, computer and process-control applications demanding small size, low cost and high reliability. If required, their design "flexibility" allows for easy modification to your application-specific requirements.

### FEATURES

- Lowest cost! Highest reliability!
- 100% SMT-on-pcb, including magnetics
- 100% automatically assembled
- Standard "DIP" package and pinouts
- Fully isolated, 1000Vdc guaranteed
- 5, 12 or 15 Volt outputs
- Choice of 3 wide-range inputs:
  - 4.5-9 Volts
  - 9-18 Volts
  - 18-72 Volts
- Guaranteed efficiencies to 73%
- -40 to +75°C full-power operation
- Internal input/output filtering
- UL1950/C22.2 No. 950/IEC950 certified
- Modifications and customs for OEM's

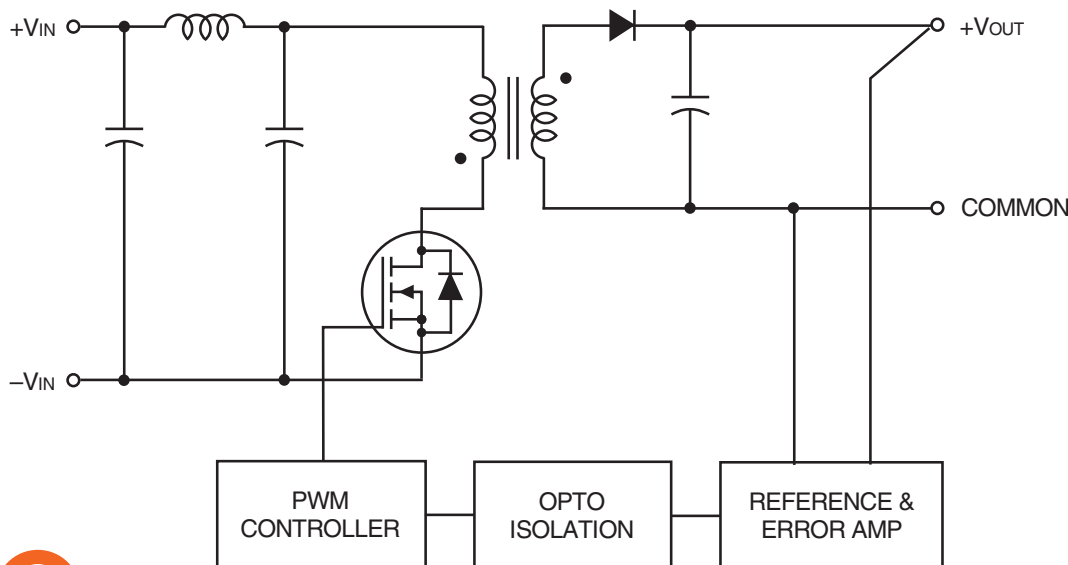

Figure 1. Simplified Block Diagram



Performance Specifications and Ordering Guide <sup>①</sup>

Model <sup>⑤</sup>	Output				Input				Efficiency		Package (Case, Pinout)	
	V <sub>OUT</sub> (Volts)	I <sub>OUT</sub> (mA, Max.)	R/N (mVp-p) <sup>②</sup>		Regulation (Max.) <sup>③</sup>		V <sub>IN</sub> Nom. (Volts)	Range (Volts)	I <sub>IN</sub> <sup>④</sup> (mA)	Min.		Typ.
			Typ.	Max.	Line	Load						
UST-5/500-D12-C	5	500	75	120	±0.2%	±0.5%	12	9-18	25/282	70%	74%	C1, P1
UST-5/500-D48-C	5	500	75	120	±0.2%	±0.5%	48	18-72	7/69	71%	75%	C1, P1
<b>OBSOLETE</b> * UST-12/250-D12-C	12	250	75	150	±0.5%	±0.5%	12	9-18	25/338	72%	74%	C1, P1
UST-12/250-D48-C	12	250	75	150	±0.5%	±0.5%	48	18-72	8/81	73%	77%	C1, P1
<b>OBSOLETE</b> * UST-15/200-D12-C	15	200	75	150	±0.5%	±0.5%	12	9-18	25/333	73%	75%	C1, P1
UST-15/200-D48-C	15	200	75	150	±0.5%	±0.5%	48	18-72	8/81	73%	77%	C1, P1
<b>OBSOLETE</b> UST-5/500-D5-C	5	500	75	120	±0.2%	±0.5%	5	4.5-9	18/676	72%	74%	C1, P1
<b>OBSOLETE</b> UST-12/250-D5-C	12	250	75	150	±0.5%	±0.5%	5	4.5-9	30/800	73%	75%	C1, P1
<b>OBSOLETE</b> UST-15/200-D5-C	15	200	75	150	±0.5%	±0.5%	5	4.5-9	30/800	73%	75%	C1, P1

**\* LAST TIME BUY: AUGUST 31, 2014. CLICK HERE FOR OBSOLESCENCE NOTICE OF FEBRUARY 2014.**

**As of September 2014, ONLY the following part numbers will be available: UST-5/500-D12-C; UST-5/500-D48-C; UST-12/250-D48-C; UST-15/200-D48-C**

- ① Typical at T<sub>A</sub> = +25°C under nominal line voltage and full-load conditions unless otherwise noted.
- ② Ripple/Noise (R/N) measured over a 20MHz bandwidth.
- ③ 10% to 100% load.
- ④ Nominal line voltage, no-load/full-load conditions.
- ⑤ These are not complete model numbers. Please refer to the part number structure when ordering.

**PART NUMBER STRUCTURE**

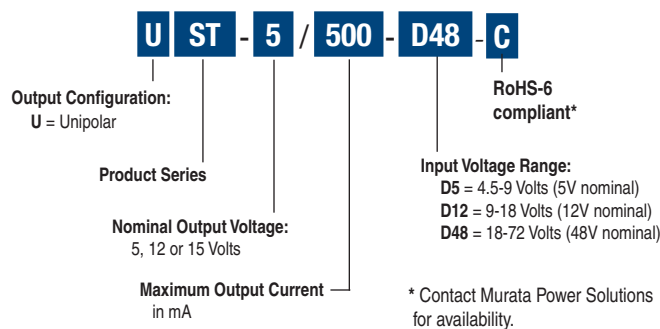

**MECHANICAL SPECIFICATIONS**

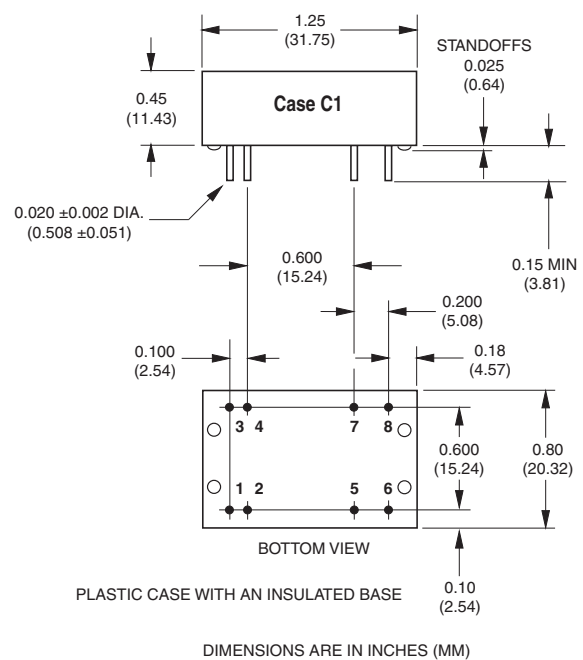

**TEMPERATURE DERATING**

Output Power vs. Ambient Temperature  
V<sub>IN</sub> Nominal, Natural Convection

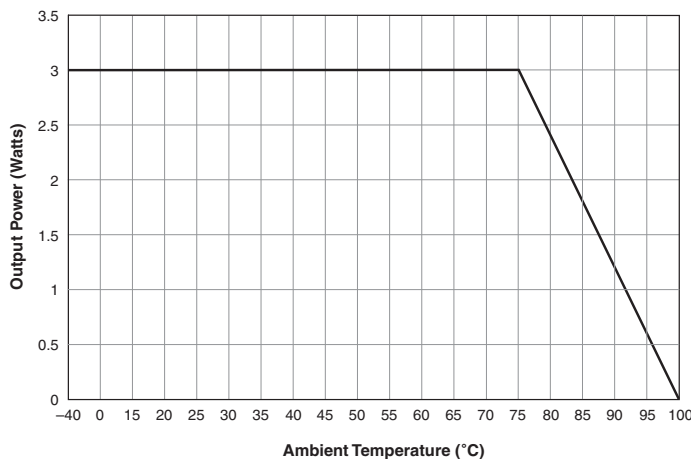

I/O Connections	
Pin	Function P1
1	+Vin
2	+Vin
3	-Vin
4	-Vin
5	Common
6	+Vout
7	Common
8	+Vout

Dimensions are in inches (mm shown for ref. only).

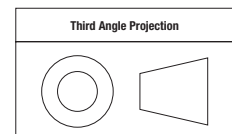

Tolerances (unless otherwise specified):  
 .XX ± 0.02 (0.5)  
 .XXX ± 0.010 (0.25)  
 Angles ± 2°

Components are shown for reference only.

### Performance/Functional Specifications

Typical @ T<sub>A</sub> = +25°C under nominal line voltage and full-load conditions, unless noted. ①

Input	
<b>Input Voltage Range:</b>	
"D5" Models	4.5-9 Volts (5V nominal)
"D12" Models	9-18 Volts (12V nominal)
"D48" Models	18-72 Volts (48V nominal)
<b>Input Current</b>	See Ordering Guide
<b>Input Filter Type ②</b>	Pi
<b>Reverse-Polarity Protection</b>	Yes (Instantaneous, 2A maximum)
Output	
<b>V<sub>OUT</sub> Accuracy (50% load)</b>	±1%, maximum
<b>Temperature Coefficient</b>	±0.02% per °C
<b>Ripple/Noise (20MHz BW) ②</b>	See Ordering Guide
<b>Line/Load Regulation</b>	See Ordering Guide
<b>Efficiency</b>	See Ordering Guide
<b>Isolation Voltage ③</b>	1000Vdc, minimum
<b>Short Circuit Protection: ④</b>	
"D5" Models	Power-limiting technique, auto-recovery
"D12" and "D48" Models	Hiccup technique, auto-recovery
Dynamic Characteristics	
<b>Transient Response (50% load step)</b>	200µsec to ±1.5% of final value
<b>Switching Frequency:</b>	
"D48" Models	200kHz
"D5" and "D12" Models	170kHz
Environmental	
<b>Operating Temperature (Ambient, no derating)</b>	-40 to +75°C
<b>Storage Temperature</b>	-40 to +100°C
Physical	
<b>Dimensions</b>	1.25" x 0.8" x 0.45" (31.8 x 20.3 x 11.4mm)
<b>Case Material</b>	Diallyl phthalate, UL94V-0-rated
<b>Pin Material</b>	Gold-plated copper alloy w/nickel underplate
<b>Weight</b>	0.5 ounces (14.2 grams)

① These power converters require a minimum 10% loading to maintain specified regulation. Operation under no-load conditions will not damage these devices; however, they may not meet all listed specifications.

② Application-specific internal input/output filtering can be recommended for quantity orders and perhaps added internally upon request. Contact DATEL Applications Engineering for details.

③ Devices can be screened for quantity orders or modified for higher guaranteed isolation voltages. Contact DATEL Applications Engineering for details.

④ The current limit inception point is dependent on the input voltage. Therefore, it is possible to draw current beyond the rated capacity. Users should fully characterize their load conditions.

### Absolute Maximum Ratings

<b>Input Voltage:</b>	
"D5" Models	12 Volts
"D12" Models	20 Volts
"D48" Models	80 Volts
<b>Input Reverse-Polarity Protection</b>	Current must be <2A. Brief duration only. Fusing recommended.
<b>Output Overvoltage Protection</b>	None
<b>Output Current</b>	Maximum current and short-circuit duration are model dependent. "D12" and "D48" models can withstand sustained output short circuits.
<b>Storage Temperature</b>	-55 to +100°C
<b>Lead Temperature (soldering, 10 sec.)</b>	+280°C

These are stress ratings. Exposure of devices to greater than any of these conditions may adversely affect long-term reliability. Proper operation under conditions other than those listed in the Performance/Functional Specifications Table is not implied.

### TECHNICAL NOTES

#### Floating Outputs

Since these are isolated DC/DC converters, their outputs are "floating." Users may ground either the Common (pins 5 and 7) for normal usage or the positive side (+Output, pins 6 and 8) to effectively reverse the output polarity.

#### Filtering and Noise Reduction

All UST 3 Watt DC/DC Converters achieve their rated ripple and noise specifications without the use of external input/output capacitors. In critical applications, input/output ripple and noise may be further reduced by installing electrolytic capacitors across the input terminals and/or low-ESR tantalum or electrolytic capacitors across the output terminals. The caps should be located as close to the power converters as possible. Typical values are listed in the tables below. In many applications, using values greater than those listed will yield better results.

##### To Reduce Input Ripple

"D5" Models	47µF, 15V
"D12" Models	10µF, 35V
"D48" Models	4.7µF, 100V

##### To Reduce Output Ripple

5V Outputs	47µF, 10V, Low ESR
12/15V Outputs	22µF, 20V, Low ESR

In critical, space-sensitive applications, DATEL may be able to tailor the internal input/output filtering of these units to meet your specific requirements. Contact our Applications Engineering Group for additional details.

### Input Fusing

Certain applications and/or safety agencies may require the installation of fuses at the inputs of power conversion components. For DATEL UST 3 Watt DC/DC Converters, you should use fast-blow type fuses with values no greater than the following:

V <sub>IN</sub> Range	Fuse Value
"D5"	1.5A
"D12"	1A
"D48"	0.5A

### EMI RADIATED EMISSIONS

If you're designing with EMC in mind, please note that all of DATEL's UST 3 Watt DC/DC Converters have been characterized for radiated and conducted emissions in our new EMI/EMC laboratory. Testing is conducted in an EMCO 5305 GTEM test cell utilizing EMCO automated EMC test software. Radiated emissions are tested to the limits of FCC Part 15, Class B and CISPR 22 (EN 55022), Class B. Correlation to other specifications can be supplied upon request. Radiated emissions plots to FCC and CISPR 22 for model UST-5/500-D48 appear below.

**UST-5/500-D48 Radiated Emissions  
FCC Part 15 Class B, 3 Meters  
Converter Output = +5Vdc @ +450mA**

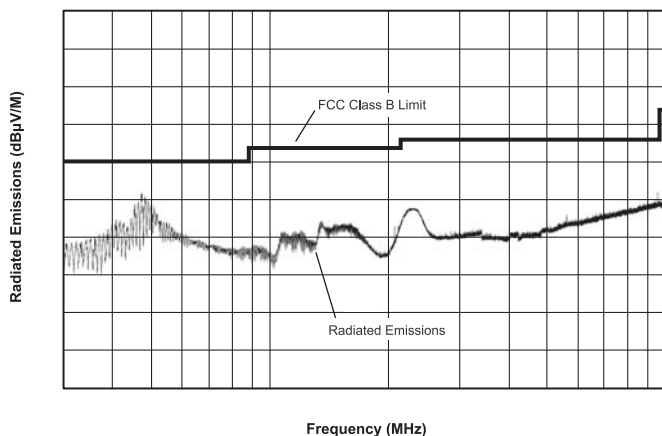

**UST-5/500-D48 Radiated Emissions  
EN 55022 Class B, 10 Meters  
Converter Output = +5Vdc @ +450mA**

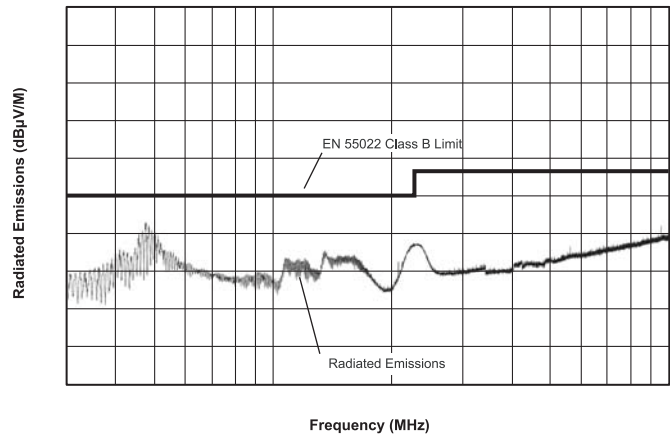

### CUSTOM CAPABILITIES

DATEL's world-class design, development and manufacturing team stands ready to work with you to deliver the exact power converter you need for your demanding, large volume, OEM applications. And ... we'll do it on time and within budget!

Our experienced applications and design staffs; quick-turn prototype capability; highly automated, SMT assembly facilities; and in-line SPC quality-control techniques combine to give us the unique ability to design and deliver any quantity of power converters to the highest standards of quality and reliability.

We have compiled a large library of DC/DC designs that are currently used in a variety of telecom, medical, computer, railway, aerospace and industrial applications. We may already have the converter you need.

Contact us. Our goal is to provide you the highest-quality, most cost-effective power converters available.

Murata Power Solutions, Inc.  
11 Cabot Boulevard, Mansfield, MA 02048-1151 U.S.A.  
ISO 9001 and 14001 REGISTERED



**This product is subject to the following [operating requirements](#) and the [Life and Safety Critical Application Sales Policy](#):  
Refer to: <http://www.murata-ps.com/requirements/>**

Murata Power Solutions, Inc. makes no representation that the use of its products in the circuits described herein, or the use of other technical information contained herein, will not infringe upon existing or future patent rights. The descriptions contained herein do not imply the granting of licenses to make, use, or sell equipment constructed in accordance therewith. Specifications are subject to change without notice. © 2014 Murata Power Solutions, Inc.